

- ① Abbreviation type name of MAX series
M1F : MAX1600F
M1T : MAX1600T
M3T : MAX3200T
- ② Slot 8 Output module
- ③ Slot 7 Output module
- ④ Slot 6 Output module
- ⑤ Slot 5 Output module
- ⑥ Slot 4 Output module
- ⑦ Slot 3 Output module
- ⑧ Slot 2 Output module
- ⑨ Slot 1 Output module
- ⑩ Parallel code
- ⑪ Series and option code
Refer to instruction manual

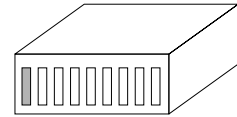

8 7 6 5 4 3 2 1
Slot

* The number of slot is different depending on the model.

SPECIFICATIONS

	MODEL	MAX1600F (M1F)	MAX1600T (M1T)	MAX3200T (M3T)	
INPUT	VOLTAGE[V]	AC85 - 264 1 φ / DC120 - 350	AC170 - 264 3 φ	AC170 - 264 3 φ	
	FREQUENCY[Hz]	47 - 63	47 - 63	47 - 63	
	CURRENT[A]	AC100V *1	19typ	-	-
		AC200V *2	10typ	6.5typ	13typ
	POWER FACTOR	AC100V *1	0.99typ	-	-
		AC200V *2	0.95typ	0.95typ	0.95typ
	INRUSH CURRENT [A]	AC100V	20/40typ (Primary inrush current/Secondary inrush current)	-	-
		AC200V	40/40typ (Primary inrush current/Secondary inrush current)	40typ	40typ
EFFICIENCY[%]	AC100V *1	78typ	-	-	
	AC200V *2	82typ	85typ	85typ	
LEAKAGE CURRENT [mA]	*3	1.5max	2max	2max	
OUTPUT	NUMBER OF SLOT	*4	4	8	
	TOTAL MAXIMUM POWER[W]	AC90 - 150V *5	1500	-	-
		AC170 - 264V *5	1600	1600	3200
	START-UP TIME [ms]	AC100V *1	700typ	-	-
		AC200V *2	500typ	500typ	500typ
HOLD-UP TIME[ms]	*1	20typ	20typ	20typ	
FUNCTION	ALARM	FAN ALARM	FAN AND OPEN PHASE ALARM	FAN AND OPEN PHASE ALARM	
ISOLATION	INPUT-OUTPUT, RC	AC3,000V 1minute, Cutoff current=25mA, DC500V 50MΩ min (At Room Temperature) (Cutoff current = 100mA : MAX3200T)			
	INPUT-FG	AC2,000V 1minute, Cutoff current=25mA, DC500V 50MΩ min (At Room Temperature)			
	OUTPUT, RC-FG	AC500V 1minute, Cutoff current=100mA, DC500V 50MΩ min (At Room Temperature)			
ENVIRONMENT	OPERATING TEMP., HUMID. AND ALTITUDE *5	-20 to +65°C, 20 - 90%RH (Non condensing) (Refer to DERATING CURVE), 3,000m (10,000feet) max			
	STORAGE TEMP., HUMID. AND ALTITUDE	-20 to +75°C, 20 - 90%RH (Non condensing) 9,000m (30,000feet) max			
	VIBRATION	19.6m/s ² , 10 - 55Hz, 3minutes period, 60minutes each along X, Y and Z axis			
	IMPACT	196.1m/s ² , 11ms, once each X, Y and Z axis			
SAFETY AND NOISE REGULATIONS	AGENCY APPROVALS	UL60950, C-UL (CSA60950), EN60950, EN50178, Complies with DEN-AN (At only AC input)			
	CONDUCTED NOISE	Complies with FCC-B, VCCI-B, CISPR22-B and EN55022-B	Complies with FCC-A, VCCI-A, CISPR22-A and EN55011-A		
	HARMONIC ATTENUATOR	Complies with IEC61000-3-2	-	-	
OTHERS	CASE SIZE *6	200 X 97 X 300mm (W X H X D)	200 X 97 X 300mm (W X H X D)	340 X 97 X 300mm (W X H X D)	
	WEIGHT	7kg max	7kg max	14kg max	
	COOLING METHOD	Forced cooling (built-in)			

*1 It is a value when M1F-HFEC-00 (MAX1600F : 5V80A, 12V34A, 15V27A, 24V17A) outputs 1500W. The value changes by composing the output modules.
 *2 It is a value when M1F-HFEC-00 (MAX1600F : 5V80A, 12V34A, 15V27A, 24V17A) outputs 1600W or M1T-HFEC-00 (MAX1600T : 5V80A, 12V34A, 15V27A, 24V17A) outputs 1600W or M3T-HHFFEECC-00 (MAX3200T : 5V80A X2, 12V34A X2, 15V27A X2, 24V17A X2) outputs 3200W. The value changes by composing the output modules.

*3 Complies with IEC60950 at AC240V 60Hz.
 *4 Each output module is insulated.
 *5 Refer to derating.
 *6 Case size contains neither the terminal blocks (cover) nor the screw.

MAX1600F / MAX1600T external view

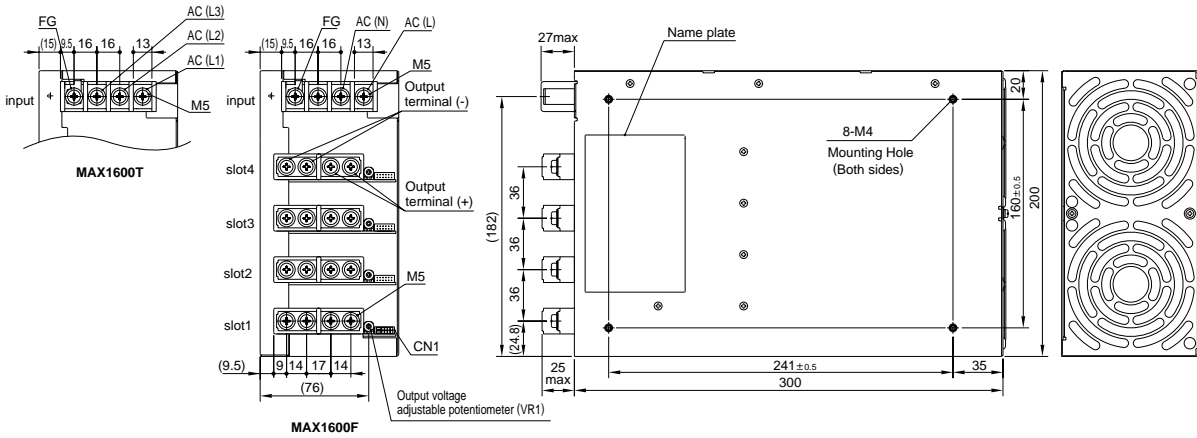

MAX

- ※ Tolerance : ± 1
- ※ Mass : 7kg or less
- ※ PCB Material/thickness : FR-4/1.6mm
- ※ Chassis material : Stainless steel SUS430
- ※ Dimensions in mm
- ※ Mounting torque : $1.5N \cdot m$ (16kgf · cm) max
- ※ Keep drawing current per terminal below 80A of output terminal.
- ※ The housing for the remote sensing unused is mounted on CN1 of each output module.
However, when the output module is connected in parallel, the housing is mounted on only master output module.
- ※ Output terminal covers are appended.

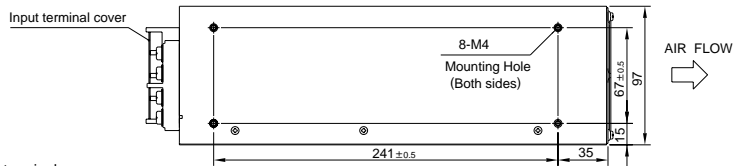

MAX3200T external view

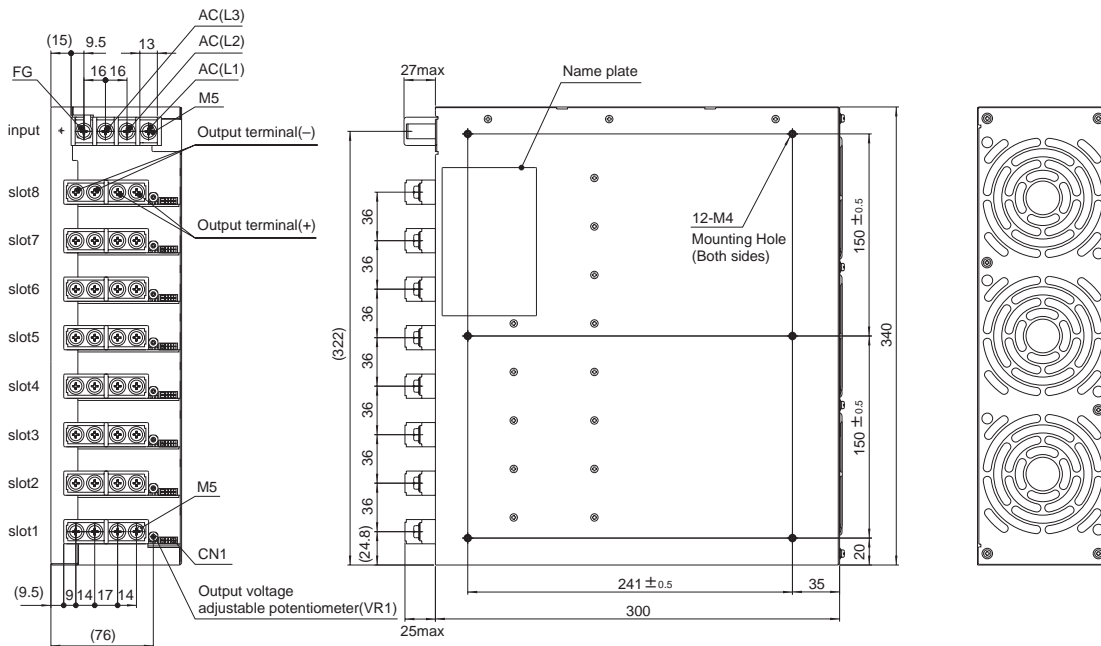

- ※ Tolerance : ± 1
- ※ Mass : 14kg or less
- ※ PCB Material/thickness : FR-4/1.6mm
- ※ Chassis material : Stainless steel SUS430
- ※ Dimensions in mm
- ※ Mounting torque : $1.5N \cdot m$ (16kgf · cm) max
- ※ Keep drawing current per terminal below 80A of output terminal.
- ※ The housing for the remote sensing unused is mounted on CN1 of each output module.
However, when the output module is connected in parallel, the housing is mounted on only master output module.
- ※ Output terminal covers are appended.

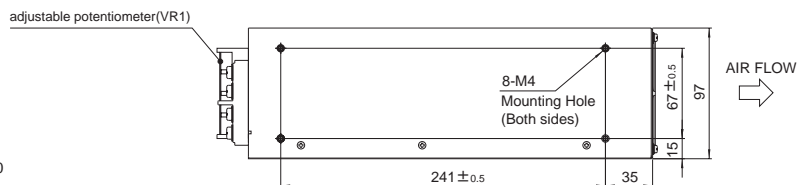

Output module specifications

ITEM	CODE	A	B	C	D	E	F	G	H	I	O
Number of slots used		1	1	1	1	1	1	1	1	1	1
VOLTAGE[V]		2	3.3	5	7.5	12	15	18	24	28	BLANK PANEL
CURRENT[A]		80	80	80	54	34	27	22	17	14.5	
LINE REGURATION[mV]max		20	20	20	30	48	60	72	96	112	
LOAD REGURATION[mV]max		40	40	40	60	100	120	150	150	180	
RIPPLE [mV]max	0 to +50°C*1	80	80	80	120	120	120	120	120	120	
	-20 to 0°C*1	140	140	140	160	160	160	160	160	160	
RIPPLE NOISE [mV]max	0 to +50°C*1	120	120	120	150	150	150	150	150	150	
	-20 to 0°C*1	160	160	160	180	180	180	180	180	180	
TEMPRATURE COEFFICIENT[mV]max	0 to +50°C	40	40	50	75	120	150	180	240	280	
	-10 to +50°C	60	60	75	120	180	225	270	360	420	
DRIFT[mV]max	*2	12	12	20	30	48	60	72	96	112	
OUTPUT VOLTAGE SETTING[V]		2.00 - 2.06	3.30 - 3.40	5.00 - 5.15	7.50 - 7.80	12.00 - 12.48	15.00 - 15.60	18.00 - 18.72	24.00 - 24.96	28.00 - 29.12	
OUTPUT VOLTAGE ADJUSTMENT RANGE[V]		1.98 - 2.20	2.64 - 3.63	4.00 - 5.50	6.00 - 8.25	9.60 - 13.20	12.00 - 16.50	14.40 - 19.80	19.20 - 26.40	22.40 - 30.80	
OVERCURRENT PROTECTION		Works over 105% of rated current automatic recovery									
OVERVOLTAGE PROTECTION[V]		4.00 - 5.50	4.00 - 5.50	5.75 - 7.00	8.63 - 10.50	13.80 - 16.80	17.25 - 21.00	20.70 - 25.20	27.60 - 33.60	32.20 - 39.20	
OUTPUT CURRENT IN PARALLEL[A] *3	TWO MODULES IN PARALLEL	144	144	144	97	61	49	40	31	26	-
	THREE MODULES IN PARALLEL	216	216	216	146	92	73	60	46	40	-
	FOUR MODULES IN PARALLEL	300	300	300	195	125	100	80	63	54	-
	FIVE MODULES IN PARALLEL	360	360	360	243	153	122	100	77	66	-
	SIX MODULES IN PARALLEL	444	444	444	292	196	149	120	92	80	-
	SEVEN MODULES IN PARALLEL	516	516	516	341	217	173	140	107	94	-
	EIGHT MODULES IN PARALLEL	600	600	600	390	250	200	160	127	108	-

- *1 Measured by 20MHz oscilloscope or Ripple-Noise meter (Equivalent to KEISOKU-GIKEN : RM101).
Ripple and Ripple Noise is measured by using measuring board with capacitor of 470 μF between 20mm to 100mm from the output terminal.
- *2 Drift is change in DC output for an eight hour period after a half-hour warm-up at 25°C, with the input voltage held constant at the rated input/output.
- *3 Modularity in parallel are built to order and are not possible for the user to assemble them.

Block diagram

● MAX1600F

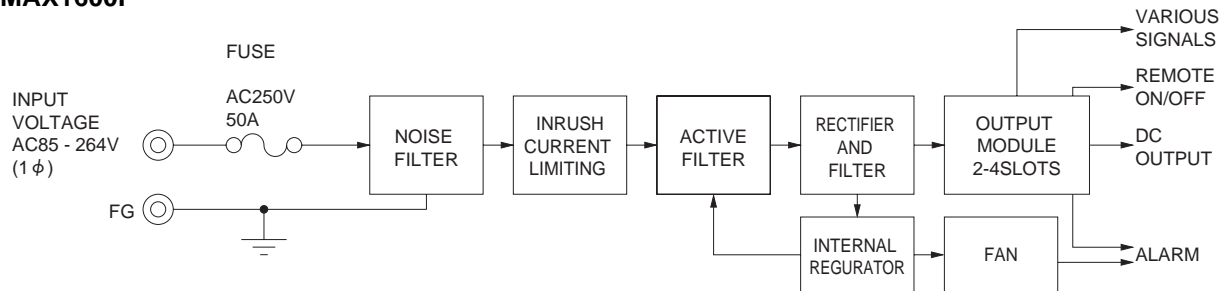

● MAX1600T / MAX3200T

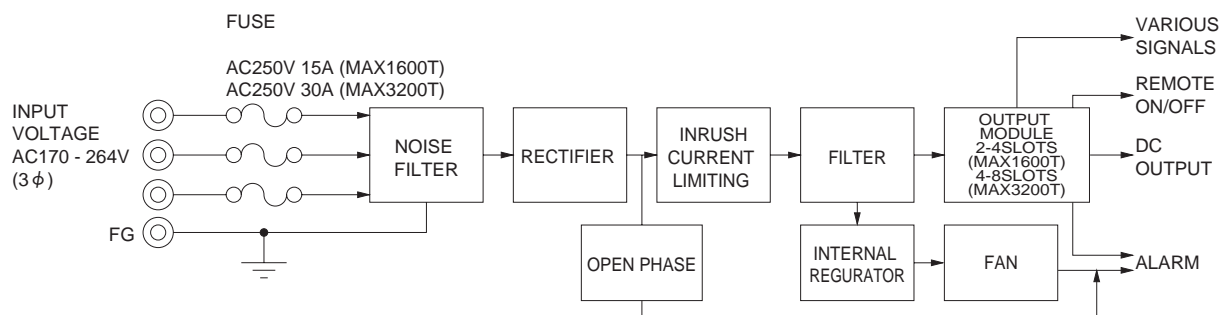

1 Ordering information C-36**2** Function C-37

2.1	Input voltage range	C-37
2.2	Inrush current limiting	C-37
2.3	Overcurrent protection	C-37
2.4	Overvoltage protection	C-37
2.5	Thermal protection	C-37
2.6	External output voltage adjustment	C-38
2.7	Remote ON/OFF	C-38
2.8	Remote sensing	C-38
2.9	Isolation	C-39
2.10	Alarm	C-39

3 Series operation and Parallel operation C-39

3.1	Series operation	C-39
3.2	Parallel operation/Master-slave operation	C-40

4 Assembling and installation method C-40

4.1	Installation method	C-40
4.2	Derating	C-41

1 Ordering information

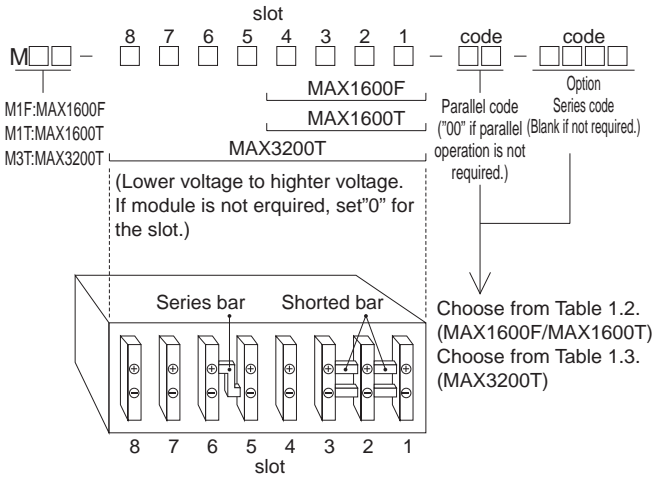

Table 1.1 Output module code

Code	A	B	C	D	E	F	G	H	I	O
Output voltage [V]	2	3.3	5	7.5	12	15	18	24	28	Blank panel
Output current [A]	80	80	80	54	34	27	22	17	14.5	
Output power [W]	160	264	400	405	408	405	396	408	406	

Table 1.2 Parallel / Series code

Code	slot4	slot3	slot2	slot1
00	●	●	●	●
01	●	●	●—●	●
02	●	●—●	●	●
03	●	●—●—●	●	●
04	●—●	●	●	●
05	●—●—●	●	●	●
06	●—●—●—●	●	●	●
07	●—●—●—●—●	●	●	●

● : Output terminal
— : Connection

Table 1.3 Parallel / Series code

Code"a"	slot8	slot7	slot6	slot5	slot4	slot3	slot2	slot1	Code"b"
0	●	●	●	●	●	●	●	●	0
1	●	●	●—●	●	●	●	●—●	●	1
2	●	●—●	●	●	●	●—●	●	●	2
3	●	●—●—●	●	●	●	●—●—●	●	●	3
4	●—●	●	●	●	●—●	●	●	●	4
5	●—●—●	●	●	●	●—●—●	●	●	●	5
6	●—●—●—●	●	●	●	●—●—●—●	●	●	●	6
7	●—●—●—●—●	●	●	●	●—●—●—●—●	●	●	●	7
	●—●	●	●	●	●	●	●	●	8
	●—●—●	●	●	●	●	●	●	●	9
	●—●—●—●	●	●	●	●	●	●	●	A
	●—●—●—●—●	●	●	●	●	●	●	●	B
	●—●—●—●—●—●	●	●	●	●	●	●	●	C
	●—●—●—●—●—●—●	●	●	●	●	●	●	●	D
	●—●—●—●—●—●—●—●	●	●	●	●	●	●	●	E
	●—●—●—●—●—●—●—●—●	●	●	●	●	●	●	●	F

● : Output terminal
— : Connection

● Configuration rules

- After the output voltage and the output current are confirmed, the code of the output module installed in the slot1-8 is selected from Table 1.1.
Put the blank panel(code 0) in when modules are not installed in the slots.
- When output module is operated in parallel and series, the parallel code can be selected from Table 1.2 and Table 1.3 depending on whether or not the bus bar between the output modules exists.
- Do not put the blank panel in the slot1 because fan alarm and open phase alarm* (ALM signal) is output from CN1 of the slot1.
*MAX1600T/MAX3200T
- Do not put the blank panel in between the output modules connected in parallel.
- Install more than two output modules in the slot.
(MAX1600F/MAX1600T)
Install more than four output modules in the slot. (MAX3200T)
- Modules with low output voltage should be installed out of the slot1 in order.

●Example of naming

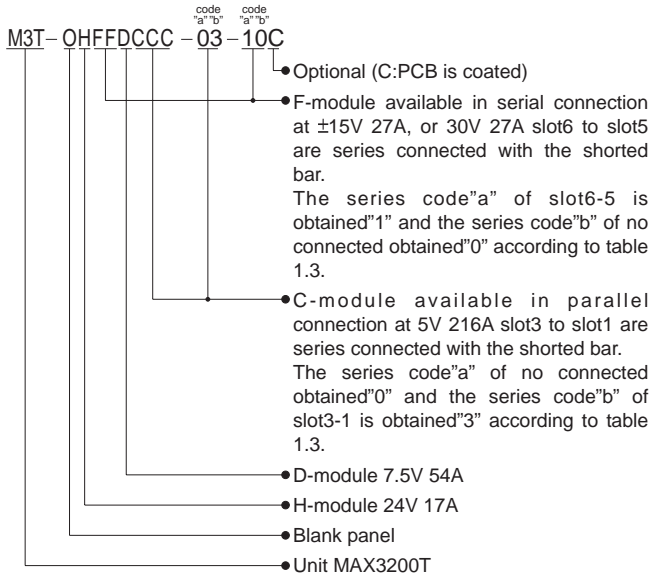

■The total output current in parallel is shown output module specifications.

2 Function

2.1 Input voltage range

●MAX1600F

- The range is from AC85V to AC264V or from DC120V to DC350V. Only AC input is available to comply with agency approval.
- If the wrong input is applied, the unit will not operate properly and/or may be damaged. Avoid the followings to cause failure of the unit to apply square waveform input voltage, which is commonly used in UPS and inverters.

●MAX1600T/MAX3200T

- The input voltage range is AC170-264V(three-phase). Units are not influenced by the phase sequence. The voltage line of the three-phase is connected, and the earthing conductor cannot be used for the three-phase four line type.

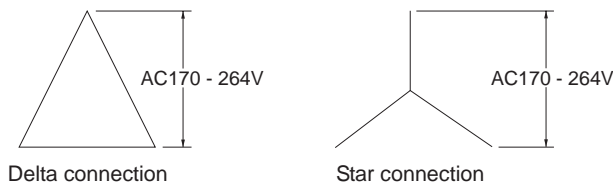

- If the wrong input or single phase input is applied, the unit will not operate properly and/or may be damaged. Avoid the followings to cause failure of the unit to apply square waveform input voltage, which is commonly used in UPS and inverters.

2.2 Inrush current limiting

- Inrush current limiting is built-in.
- If a switch on the input side is installed, it has to be the one handling the input inrush current.
- The thyristor technique is used for protection from inrush current. When power is turned ON/OFF repeatedly within a short period of time, it is necessary to have enough time between power ON and OFF to operate circuit for inrush current. When the switch of the input is turned on, the primary inrush current and secondary inrush current are generated.

MAX

2.3 Overcurrent protection

- Overcurrent protection is built-in and comes into effect at 105% of the rated current. Overcurrent protection prevents the unit from short circuit and overcurrent condition. The unit automatically recovers when the fault condition is cleared.
- If the output voltage drops more than 50% of the rated voltage in an overcurrent protection mode, the average current will also be reduced by the intermittent operation.

2.4 Overvoltage protection

- Overvoltage protection circuit is built-in and comes into effect 115 - 140% of the rated voltage(except 3.3V output voltage type : it operates at 4.0 - 5.5V). The AC input should be shut down if overvoltage protection is operation. The minimum interval of AC recycling for recovery is more than 3 minutes. The recovery time varies depending on input voltage.

2.5 Thermal protection

- Thermal protection circuit is built-in and avoid the followings to shut down at operating thermal protection.
 - When the current and the temperature which deviates from the derating characteristic are consecutive.
 - The case FAN stops or the case the wind out of FAN is interrupted and the amount of the wind decreases.
 After the input voltage is intercepted and the inside of the power supply cools enough, the return after the overheating protection operates turns on the input of the power supply again.

2.6 External output voltage adjustment

■By applying the voltage externally or connecting register externally between TRM and -S, output voltage becomes adjustable. Output level is able to be calculated by following equation① ; however, external output voltage should not be less than -0.7V and more than 2.5V.

$$\text{Output voltage} = \frac{\text{The voltage between TRM and -S}}{1 [V]} \times \text{Rated output voltage} \dots \text{①}$$

2.7 Remote ON/OFF

■Each output module has remote ON/OFF. ON/OFF of output voltage becomes available. Table 2.1 shows the specification of remote ON/OFF.

Fig.2.1 shows the way to connect remote control(Example), and followings are notes when you use the remote control.

- ①The output stops when the current is drawn in RC3. The current drowning RC3 is less than 12mA.
- ②Built-in fans do not stop even if the output is turned off with remote ON/OFF circuit.
- ③The IOG signal is output when the output voltage is turned off with remote ON/OFF.
- ④You should be careful of electric potential in series when you wire the remote control circuit,since it is not insulated from the output. Example of a circuit in series is shown in Fig.2.2.

■It is possible turn on and turn off by the remote control of the master module, because RC2 of the output module is connected with RC3 in the power supply in parallel operation. However, please note that currents necessary for the control increase more than the time used with the output module unit because RC2 and RC3 of the output module are connected in parallel.

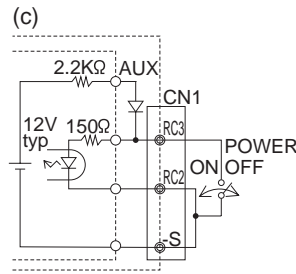
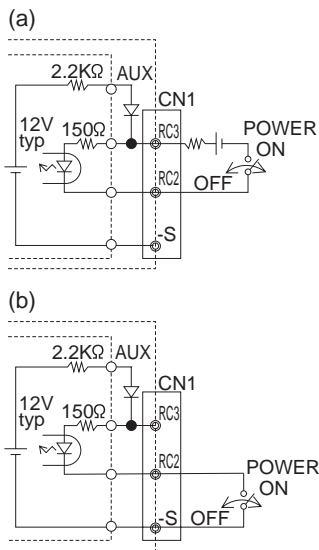

Fig.2.1 Examples of connecting remote ON/OFF of output module

Table 2.1 Specification of remote ON/OFF

Connection method		Fig.2.10(a)	Fig.2.10(b)	Fig.2.10(c)
SW Logic	Output on	SW open (0.1mA max)	SW open (0.1mA max)	SW close (0.5V max)
	Output off	SW close (3mA min)	SW close (3mA min)	SW open (0.1mA max)
pin		-	-S	-S

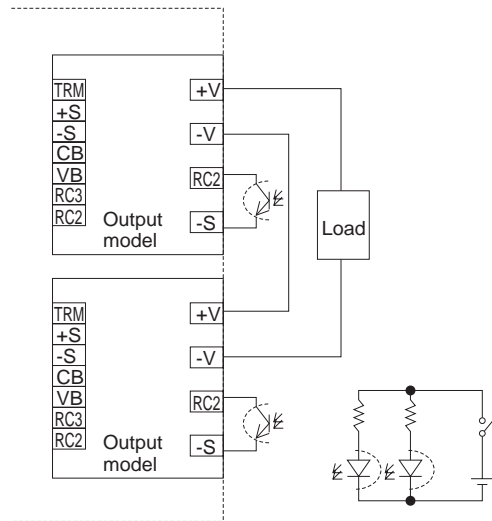

Fig.2.2 Example of remote control circuit in series operation

2.8 Remote sensing

■Remote sensing circuit is built-in each output module. ■Wiring method without using remote sensing is shown in Fig.2.3. When you do not use the remote sensing, connect between +S and +M and between -S and -M with CN1 of each output module. When the power supply is shipped out of a factory, a special harness is mounted on CN1 of the output module.

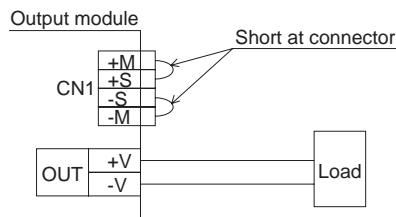

Fig.2.3 When not using remote sensing function

- Wiring method with remote sensing is shown in Fig.2.4.
- Notes, when you use the remote sensing, are shown as follows.
 - ① Note connecting wires enough because the load current flows to sensing line and an internal circuit of power supply is damaged occasionally, when defective contact of the screw such as loosening happens in the load line.
 - ② Conform the line drop should be at 0.3V or less using a thick wire from the power supply to the load.
 - ③ When remote sensing function is used, output voltage might become unstable because of a impedance of wiring and load condition. And the power supply should be evaluated enough. Following are examples to improve it.
 - -S sensing wire is removed and terminals between -M and -S are shorted.
 - C₀ and R1 are connected as above figure.
- Please ask details to us.
- When using remote sensing in parallel, you use remote sensing out of a module that should be a master module and other output module in parallel should be open between ±S and ±M.
- Do not take out the output current of ±M at CN1.

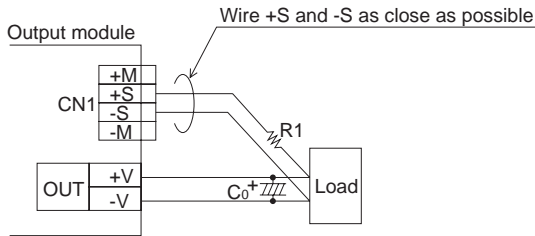

Fig.2.4 When using remote sensing function

2.9 Isolation

- For a receiving inspection, such as Hi-Pot test, gradually increase (decrease) the voltage for start(shut down). Avoid using Hi-Pot tester with the timer because it may generate voltage a few times higher than the applied voltage, at ON/OFF of a timer.

If the unit is tested on the isolation between input & output and output & FG must be shorted all output.

2.10 Alarm

- Table 2.2 shows the alarm function built-in the power supply.

Table 2.2 Explanation of alarms

Alarm		Output of alarm
ALM	When the fan stops or the power supply breaks down (or one of three phase is open)*, the alarm from CN1 of the output module of slot1.	Open collector method Good : Low(0.5Vmax at 5mA) Bad : High or open 35V 10mA max
TMP	When the thermal protection circuit of the output module operates immediately or before, the alarm outputs.	Good : High(5V typ) Bad : Low(0.5Vmax at 5mA) 35V 10mA max
IOG	When the switching operation in the output module stops.	Good : Low(0.5Vmax at 5mA) Bad : High(5V typ) 35V 10mA max

* MAX1600T / MAX3200T

- Notes, you should be careful of electric potential in series when you wire the alarm circuit, since it is not isolated from the output.

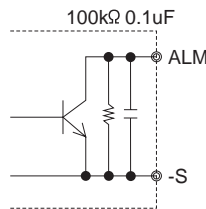

Fig.2.5 Internal circuit of ALM

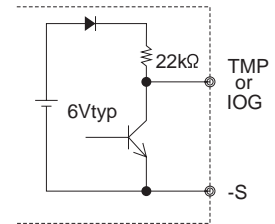

Fig.2.6 Internal circuit of TMP and IOG

3 Series operation and Parallel operation

3.1 Series operation

- Series operation is possible between the output modules in the same power supply as shown below. Output current in series connection should be lower than the lowest rated current in each unit. It is necessary to prevent the total output voltage from exceeding 60V to meeting safety agency approvals.

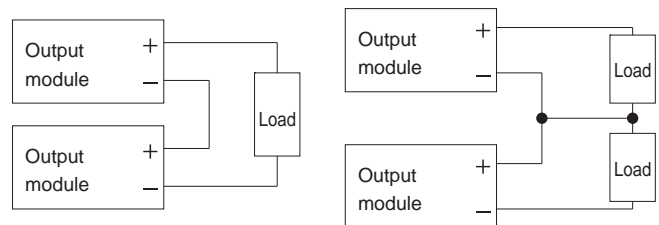

Fig.3.1 Connection method in series

3.2 Parallel operation/Master-slave operation

Parallel operation is possible between the output modules in the same power supply. (Already set up at the time of shipping out. Impossible for user to set up.)

The output terminal of the module (set up for parallel operation) should be connected with a shorted bar.

Do not apply input voltage after you remove the shorted bar because it can be damaged. The connection in parallel is shown in Fig.3.2.

Notes of parallel operation are shown as follows.

① At 10% load factor or less

- IOG may turn to be "H"
- Output voltage may slightly rise, max.5%.

② AC IN & Remote ON

- IOG signal becomes irregular for 1 second when input voltage is applied or remote ON/OFF is turned ON.

Method to set up output voltage when output module is connected in parallel.

You need to decide an output module out of modules for parallel operation and turn the volume of other output modules fully right.

You need to turn the volume in the master module and set up the output voltage. When the unit is shipped from the factory, we establish the output voltage as a master power supply whose slot number is smallest.

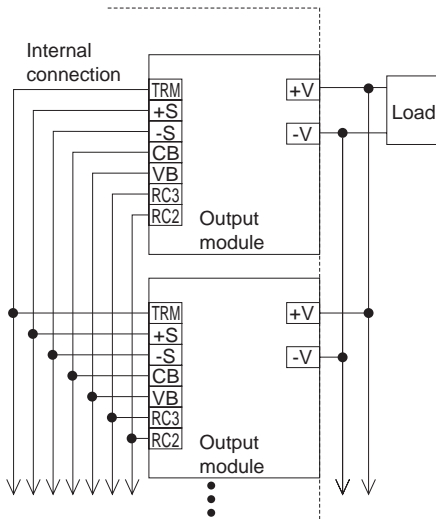

Fig.3.2 Connection method in parallel

Output current in series connection is the same as the specification of the connected module.

Please notice and set the following items.

- ① Choosing same modules in series setting in principle.
- ② The rating voltage of the total in series setting can set less than 60V.
- ③ It is impossible to use series setting with parallel setting.

Please consult us excluding the above-mentioned.

In series and parallel operation, output voltage increases like stairs due to a delay of the rise time output voltage at turn on.

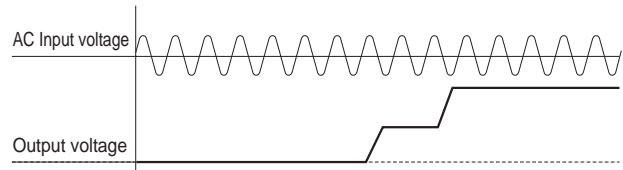

Fig.3.3 Start-up waveform in series and/or parallel operation

4 Assembling and installation method

4.1 Installation method

Fans for forced cooling are built-in.

Do not block the ventilation at suction side (terminal block side) and its opposite side.

Regular exchange is necessary for the fan, because the life expectancy ($R(t)=90\%$) of the fan depending on the use condition is shown in Fig.4.1.

Install the air filter so that the effect of cooling by the fan does not decrease when the power supply is used in a dusty place.

Fan unit for maintenance can be ordered. Refer to optional parts.

Fix firmly, considering weight, though it can be used by the installation method shown in Fig.4.2B and C.

The screw should be inserted up to 8mm max from outside of the power supply to keep a distance between inside parts and an isolation.

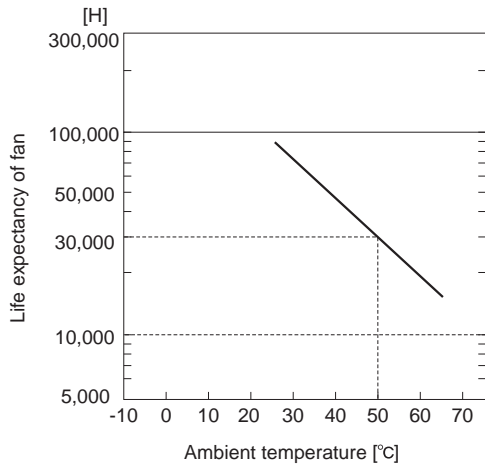

Fig.4.1 Life expectancy of fan(R(t)=90%)

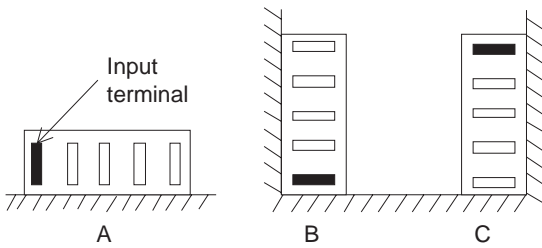

Fig.4.2 Installation method

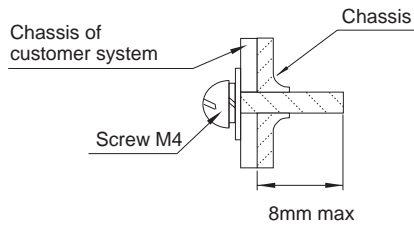

Fig.4.3 Mounting screw

4.2 Derating

●MAX1600F

- Derating curve of output module depending on ambient temperature and derating curve depending on input voltage are shown in Fig.4.4 and Fig.4.5.
- In the hatched area, the specifications of Ripple and Ripple Noise are different from other, refer to specifications of output module.

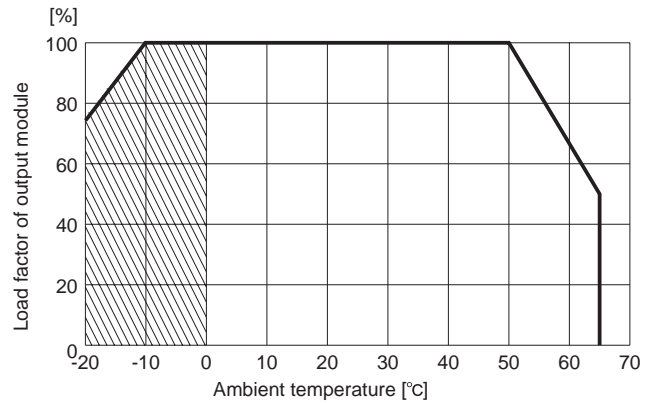

Fig.4.4 Derating curve of output module depend on ambient temperature

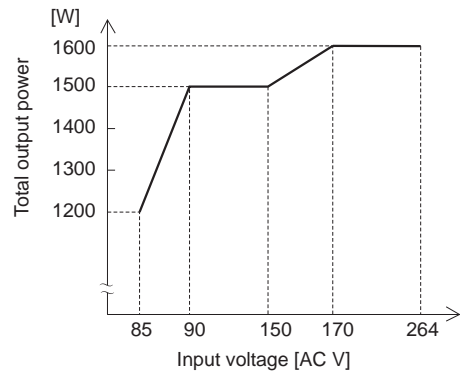

Fig.4.5 Derating curve depend on input voltage

●MAX1600T/MAX3200T

- Derating curve of output module depending on ambient temperature is shown in Fig.4.6.
- In the hatched area, the specifications of Ripple and Ripple Noise are different from other, refer to specifications of output module.

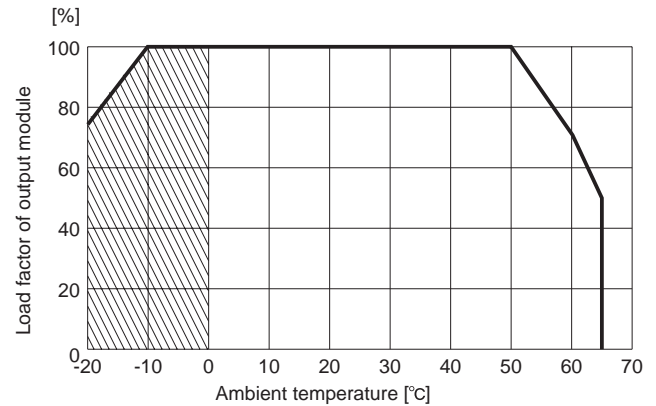
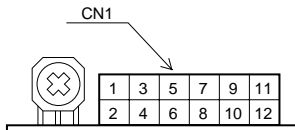

Fig.4.6 Derating curve of output module depend on ambient temperature

MAX

Function connector (CN1) pinassign



Mating connector and terminal of output module CN1

	Connector	Mating connector	Terminal	Mfr.
CN1	S12B-PHDSS	PHDR-12VS	Chain : SPHD-002T-P0.5 Loose : BPHD-001T-P0.5 : BPHD-002T-P0.5*1	J.S.T

*1 Ratchet Hand is nothing

Pin connection and function of output module CN1

Pin No.	Function
1	+M : +Output voltage monitoring
2	-M : -Output voltage monitoring
3	+S : +Remote sensing
4	-S : -Remote sensing, Signal ground
5	TRM : Adjustment of output Voltage
6	-S : -Remote sensing, Signal ground
7	RC2 : Remote ON/OFF
8	-S : -Remote sensing, Signal ground
9	RC3 : Remote ON/OFF
10	ALM : Fan alarm (and open phase alarm)*
11	IOG : Inverter operation monitor
12	TMP : Thermal detection signal

*MAX1600T / MAX3200T

Basic Characteristics Data

Model	Circuit method	Switching frequency [kHz]	Input current [A]	Rated input fuse	Inrush current protection	PCB/Pattern			Series/Parallel operation availability	
						Material	Single sided	Double sided	Series operation	Parallel operation
Input module of MAX1600F	Active filter	65	19 *1	250V 50A	SCR	FR-4		Yes	-	-
Input module of MAX1600T	Rectifier and filter	-	6.5 *2	250V 15A	SCR	FR-4		Yes	-	-
Input module of MAX3200T	Rectifier and filter	-	13 *3	250V 30A	SCR	FR-4		Yes	-	-
Output module	Forward converter	370	-	-	-	FR-4		Yes	Yes	Yes

*1 Input current is based on Modul M1F-HFEC-00 (MAX1600F : 5V80A, 12V34A, 15V27A, 24V17A) outputs 1500W at AC100V.

*2 M1T-HFEC-00 (MAX1600T : 5V80A, 12V34A, 15V27A, 24V17A) outputs 1600W at AC200V.

*3 M3T-HHFFEECC-00 (MAX3200T : 5V80A × 2, 12V34A × 2, 15V27A × 2, 24V17A × 2) outputs 3200W at AC200V.
The value changes by composing the output modules.

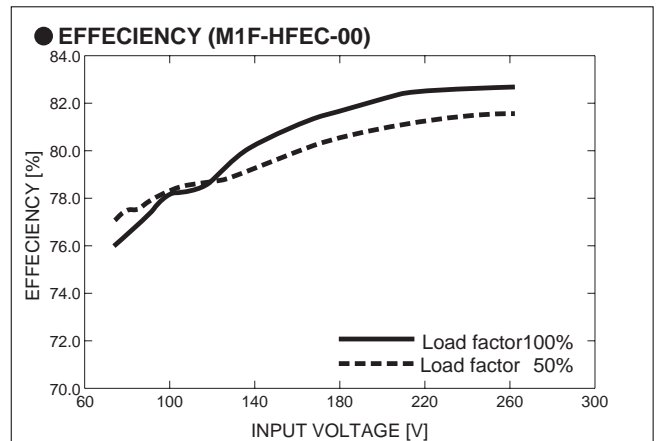
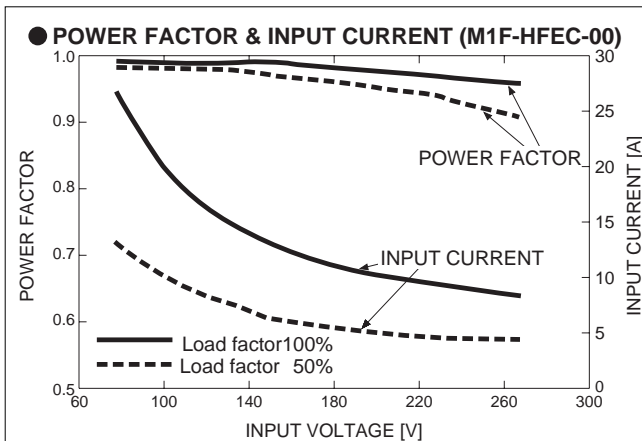
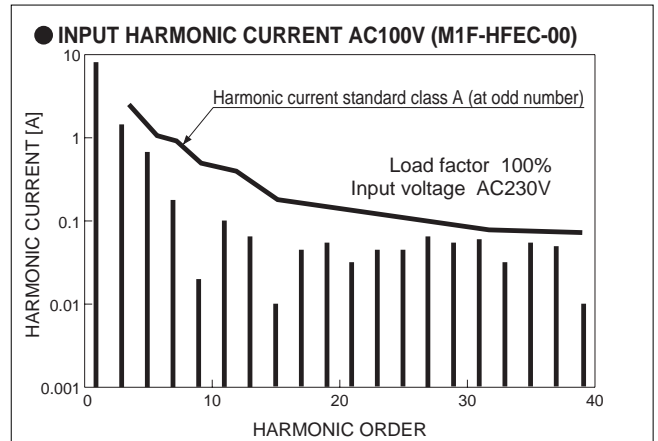
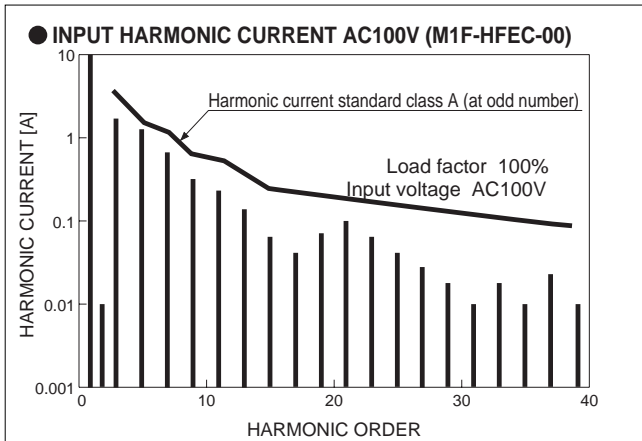
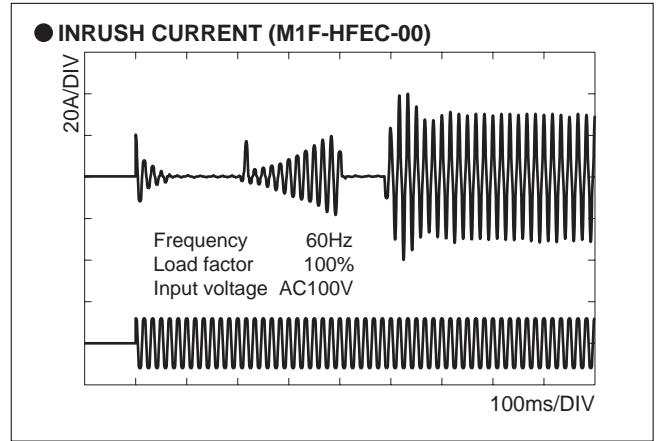
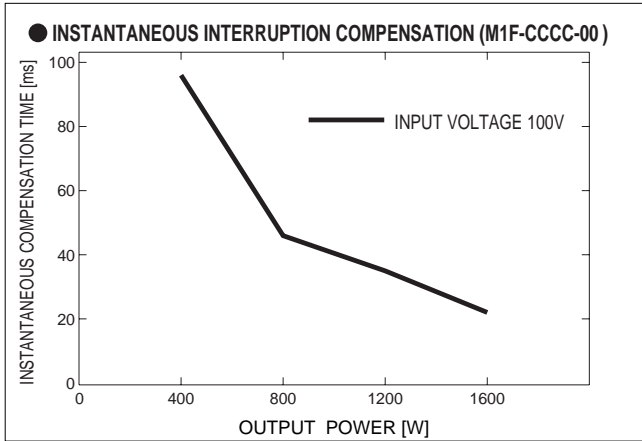
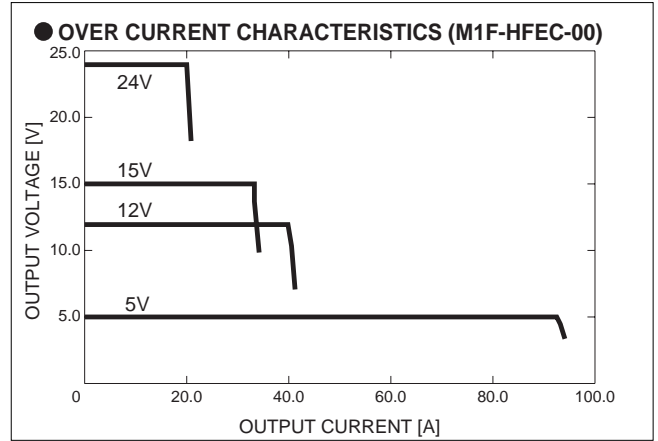
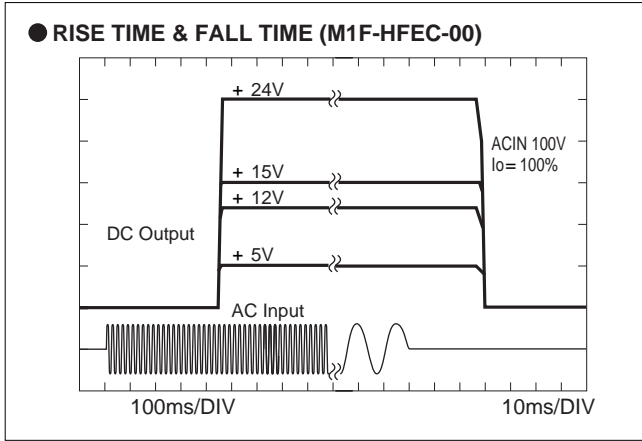

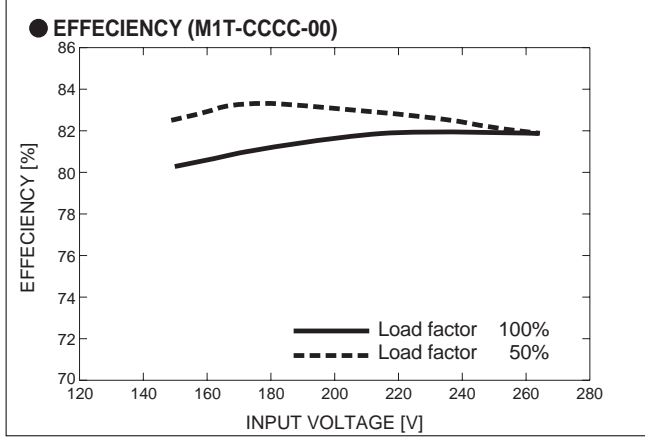
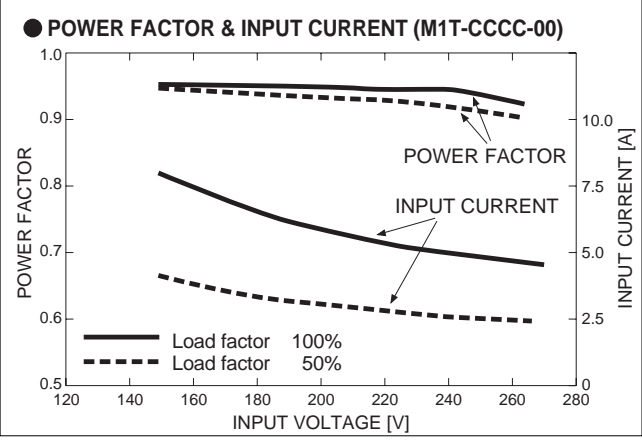
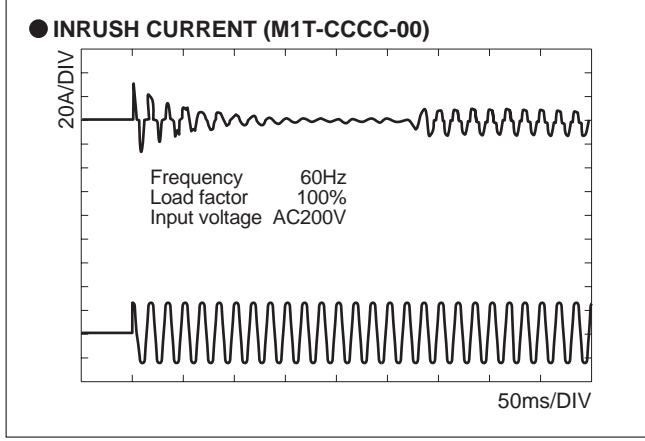
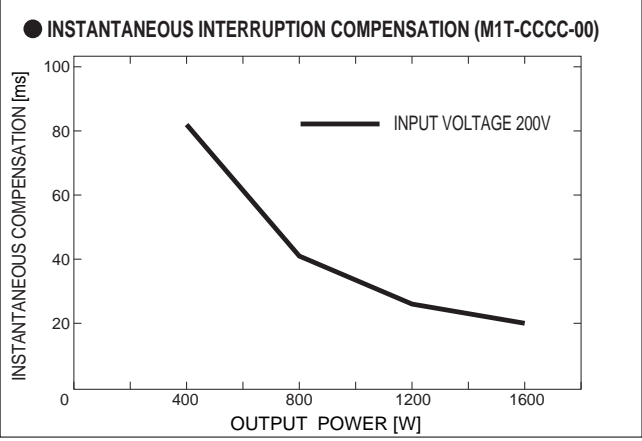
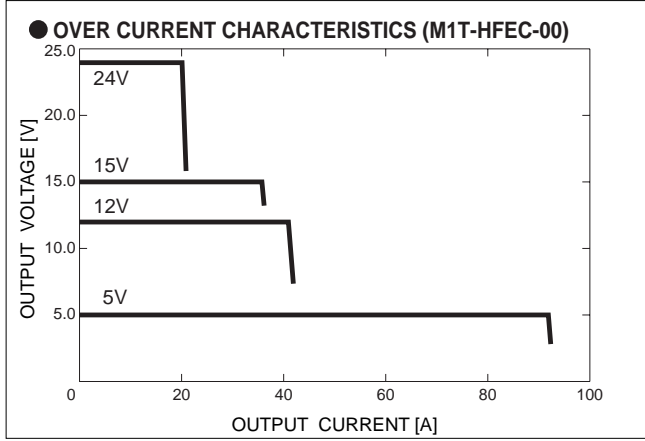
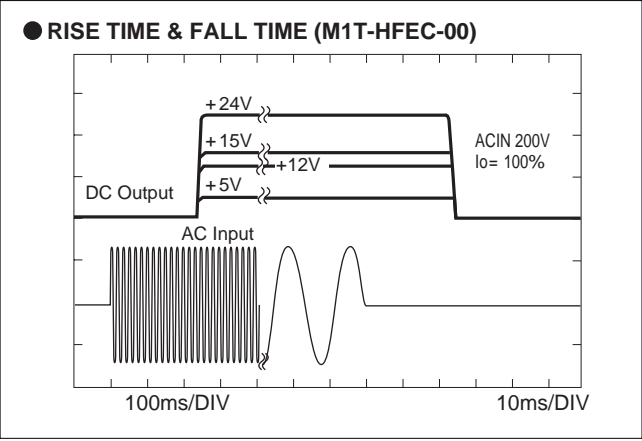

MAX

