

ISOLATED DC/DC CONVERTERS

48V Input 3.3V/25A, 5V/20A, 12V/8.33A Output, 1/8 Brick



07CY-85T Series PRELIMINARY

- Isolated
- High Efficiency
- High Power Density
- Excellent Thermal Performance
- Low Cost
- Input Under Voltage Lockout
- Output Over Voltage Shutdown
- OCP/SCP
- Over Temperature Protection
- Remote On/Off
- Output Voltage Trim
- Positive/Negative Remote Sense

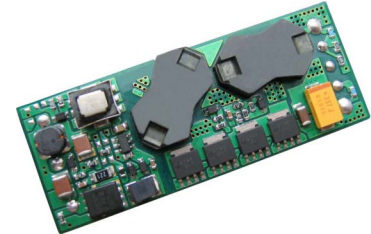

Description

The 07CY-85T Series are isolated DC/DC converters that operate from a nominal 48V source. These units provide up to 100W of output power. These units are designed to be highly efficient and cost-effective. Features include remote on/off, short circuit protection, over current protection, over temperature protection, input under voltage lockout, and output over voltage protection. These converters are provided in a compact, 1/8 brick industry standard package.

Part Selection

Output Voltage	Input Voltage	Max. Output Current	Max. Output Power	Typical Efficiency	Model Number Active High	Model Number Active Low
12.0V	36V – 75V	8.33A	100W	90%	07CY-85T120	07CY-85T12L
5.0V	36V – 75V	20A	100W	90%	07CY-85T050	07CY-85T05L
3.3V	36V – 75V	25A	85W	89%	07CY-85T033	07CY-85T03L

Note: Add “G” suffix at the end of the model number to indicate Tray Packaging.

Absolute Maximum Ratings

Parameter	Min	Typ	Max	Notes
Input Voltage (continuous)	-0.3V	-	80V	
Remote On/Off	-0.3V	-	18V	
I/O Isolation Voltage	-	-	2000V	
Ambient Temperature	-40°C	-	85°C	
Storage Temperature	-55°C	-	125°C	

Input Specifications

Parameter	Min	Typ	Max	Notes
Input Voltage	36V	48V	75V	
Input Current (full load)				
V _o =12.0V	-	-	3.0A	
V _o =5.0V	-	-	3.0A	
V _o =3.3V	-	-	2.8A	
Input Current (no load)	-	80mA	120mA	
Remote Off Input Current		2mA	5mA	
Input Reflected Ripple Current (pk-pk)	-	12mA	24mA	Tested with simulated source impedance of 10uH, 5Hz to 20MHz; use a 100uF/100V electrolytic capacitor with ESR = 1 ohm max. at 200KHz at 25°C.
Input Reflected Ripple Current (RMS)	-	2mA	4mA	
I ² t Inrush Current Transient	-	0.01A ² s	0.02A ² s	
Turn-on Voltage Threshold	32V	34V	35V	
Turn-off Voltage Threshold	30V	32V	33V	

ISOLATED DC/DC CONVERTERS

48V Input 3.3V/25A, 5V/20A, 12V/8.33A Output, 1/8 Brick



Output Specifications

Parameter	Min	Typ	Max	Notes		
Output Voltage Set Point				Vin=48V, Io=50% full load, Ta=25°C.		
Vo=12.0V	11.820V	12.0V	12.180V			
Vo=5.0V	4.925V	5.0V	5.075V			
	Vo=3.3V	3.250V	3.350V			
Line Regulation						
Vo=12.0V	-	±12mV	±24mV			
Vo=5.0V	-	±5mV	±10mV			
Vo=3.3V	-	±3mV	±7mV			
Load Regulation						
Vo=12.0V	-	±30mV	±60mV			
Vo=5.0V	-	±10mV	±20mV			
Vo=3.3V	-	±7mV	±15mV			
Regulation Over Temperature (-40°C to +85°C)						
Vo=12.0V	-	±60mV	±100mV			
Vo=5.0V	-	±45mV	±75mV			
Vo=3.3V	-	±30mV	±50mV			
Output Current						
Vo=12.0V	0A	-	8.33A			
Vo=5.0V	0A	-	20A			
Vo=3.3V	0A	-	25A			
Current Limit Threshold						
Vo=12.0V	10A	13A	16A			
Vo=5.0V	23A	29A	35A			
Vo=3.3V	30A	36A	42A			
Short Circuit Surge Transient	-	3A ² s	5A ² s			
Ripple and Noise (RMS)				Test conditions: 0-20MHz BW, with a 1uF ceramic capacitor and a 10uF Tantalum capacitor at the output.		
Vo=12.0V	-	25mV	50mV			
Vo=5.0V	-	25mV	50mV			
	Vo=3.3V	-	15mV	30mV		
Ripple and Noise (pk-pk)						
Vo=12.0V	-	100mV	150mV			
Vo=5.0V	-	100mV	150mV			
Vo=3.3V	-	55mV	100mV			
Turn on Time	-	15mS	30mS			
Overshoot at Turn on	-	0%	5%			
Output Capacitance						
Vo=12.0V	0uF	-	1000uF			
Vo=5.0V	0uF	-	10000uF			
Vo=3.3V	0uF	-	20000uF			
Transient Response						
25% ~ 50% Max Load	Overshoot	Vo=12.0V	-	300mV	500mV	Test conditions: di/dt = 0.1A/uS, Vin=48V, with a 1uF ceramic capacitor and a 10uF Tantalum capacitor at the output.
	Settling Time		-	250uS	350uS	
50% ~ 25% Max Load	Overshoot	Vo=12.0V	-	300mV	500mV	
	Settling Time		-	250uS	350uS	
25% ~ 50% Max Load	Overshoot	Vo=5.0V	-	200mV	300mV	
	Settling Time		-	200uS	300uS	
50% ~ 25% Max Load	Overshoot	Vo=5.0V	-	200mV	300mV	
	Settling Time		-	200uS	300uS	
25% ~ 50% Max Load	Overshoot	Vo=3.3V	-	150mV	200mV	
	Settling Time		-	150uS	200uS	
50% ~ 25% Max Load	Overshoot	Vo=3.3V	-	150mV	200mV	
	Settling Time		-	150uS	200uS	

Note: All specifications are typical at 25°C unless otherwise stated.

ISOLATED DC/DC CONVERTERS

48V Input 3.3V/25A, 5V/20A, 12V/8.33A Output, 1/8 Brick



General Specifications

Parameter	Min	Typ	Max	Notes
Efficiency				
Vo=12.0V	87%	90%	-	Vin=48V, Io=Io,max
Vo=5.0V	87%	90%	-	
Vo=3.3V	86%	89%	-	
Switching Frequency	270KHz	300KHz	330KHz	
Isolation capacitance	-	1500pF	-	
Output Voltage Trim Range	80%Vo	-	110%Vo	
Over Temperature Protection	-	125°C	-	
Over Voltage Protection	117%Vo	122%Vo	127%Vo	
MTBF	TBD			Calculated Per Bell Core TR-332 (Io = Nominal; Ta = 25°C)
Dimensions				
Inches (L x W x H)	2.30 x 0.896 x 0.395			
Millimeters (L x W x H)	58.42 x 22.76 x 10.03			
Weight	-	27g	-	

Note: All specifications are typical at 25°C unless otherwise stated.

Control Specifications

Parameter	Min	Typ	Max	Notes
Remote On/Off				
Signal Low (Unit On)	Active Low	-0.3V	-	0.8V
Signal High (Unit Off)		2.4V	-	
Signal Low (Unit Off)	Active High	-0.3V	-	0.8V
Signal High (Unit On)		2.4V	-	
Current Sink	0mA	-	0.75mA	

Output Trim Equations

Equations for calculating the trim resistor are shown below. The Trim Down resistor should be connected between the Trim pin and Ground pin. The Trim Up resistor should be connected between the Trim pin and the Vout. Only one of the resistors should be used for any given application.

$$R_{trimdown} = \frac{511}{|\delta|} - 10.22 [k\Omega]$$

$$R_{trimup} = \frac{(100 + \delta) \cdot V_o \cdot 5.11 - 626}{1.225 \cdot \delta} - 10.22 [k\Omega]$$

Notes:

$$\delta = \frac{(V_o_{req} - V_o)}{V_o} \times 100 [\%]$$

V_{o_req}=Desired (trimmed) output voltage [V]

Output voltage V_o=3.308V for 3.3V output; V_o=5.000V for 5.0V; V_o=12.000V for 12V output

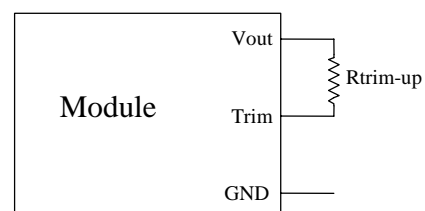
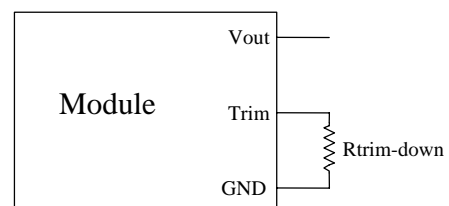

ISOLATED DC/DC CONVERTERS

48V Input 3.3V/25A, 5V/20A, 12V/8.33A Output, 1/8 Brick



Efficiency Data

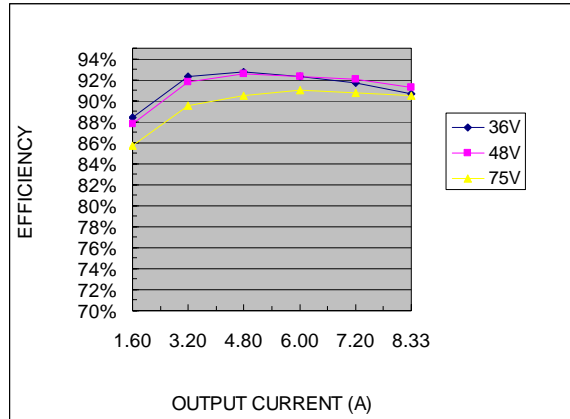

Vo=12V

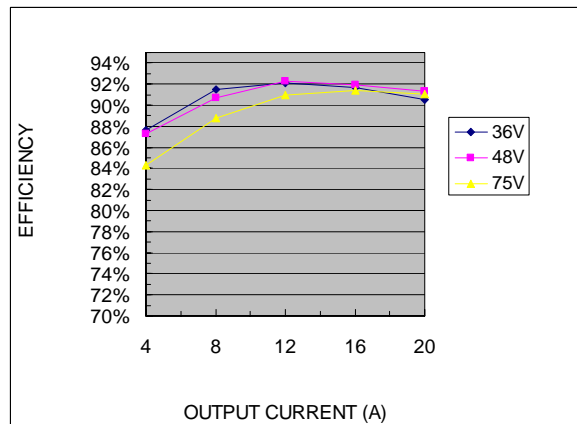

Vo=5V

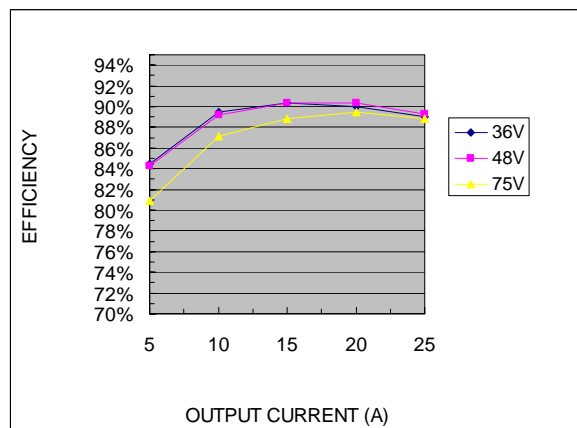

Vo=3.3V

ISOLATED DC/DC CONVERTERS

48V Input 3.3V/25A, 5V/20A, 12V/8.33A Output, 1/8 Brick



Thermal Derating Curves

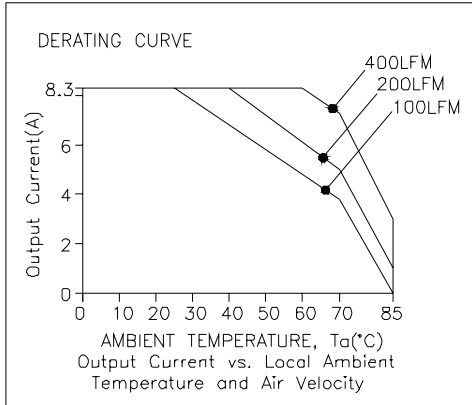

Derating curve of 07CY-85T12x output module

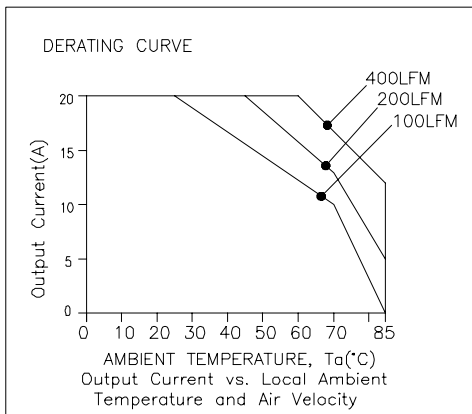
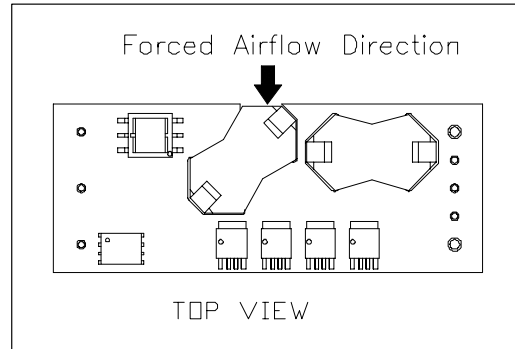

Derating curve of 07CY-85T05x output module

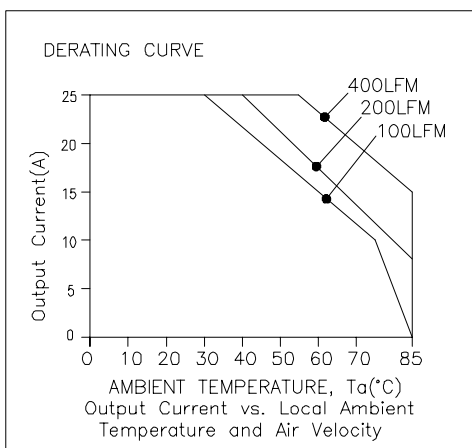
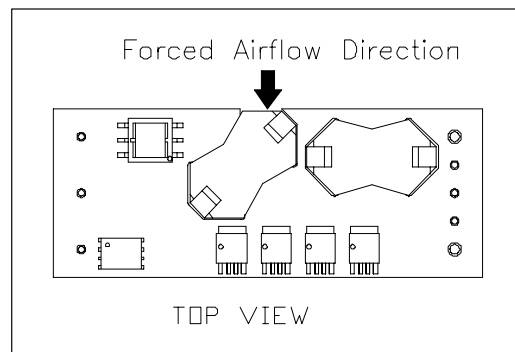

Derating curve of 07CY-85T03x output module

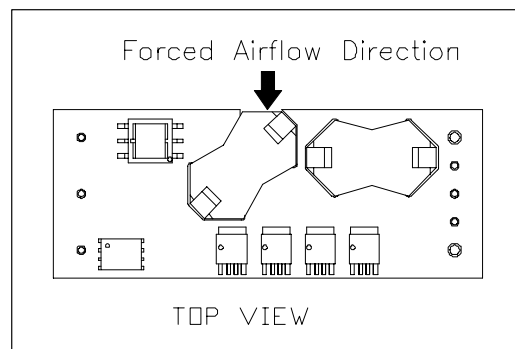

ISOLATED DC/DC CONVERTERS

48V Input 3.3V/25A, 5V/20A, 12V/8.33A Output, 1/8 Brick

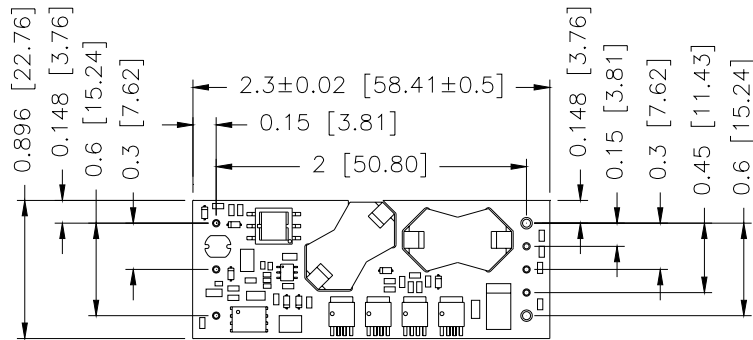

TOP VIEW

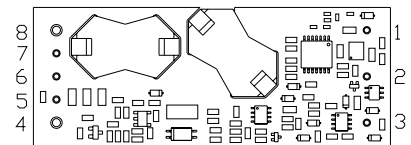

BOTTOM VIEW

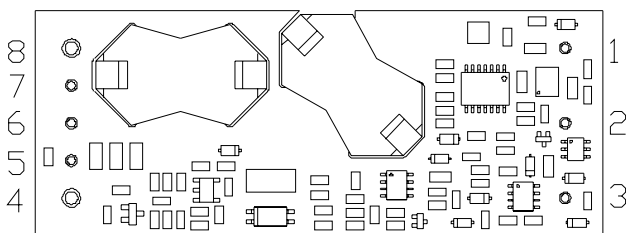
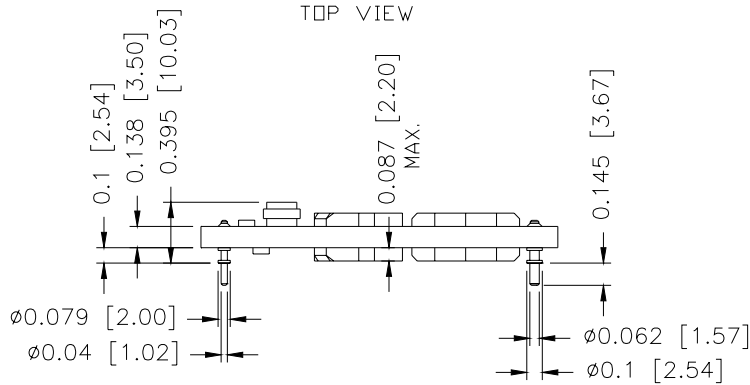

Pin Connections

Pin	Function
1	Vin+
2	Remote On/Off
3	Vin-
4	Vout-
5	Sense-
6	Trim
7	Sense+
8	Vout+

©2005 Bel Fuse Inc. Specifications subject to change without notice. 030305

CORPORATE

Bel Fuse Inc.
206 Van Vorst Street
Jersey City, NJ 07302
Tel 201-432-0463
Fax 201-432-9542
www.belfuse.com

FAR EAST

Bel Fuse Ltd.
8F/ 8 Luk Hop Street
San Po Kong
Kowloon, Hong Kong
Tel 852-2328-5515
Fax 852-2352-3706
www.belfuse.com

EUROPE

Bel Fuse Europe Ltd.
Preston Technology Management Centre
Marsh Lane, Suite G7, Preston
Lancashire, PR1 8UD, U.K.
Tel 44-1772-556601
Fax 44-1772-888366
www.belfuse.com