

QPW025A0F41/QPW025F41-H DC-DC Converter Power Module

36- 75Vdc Input, 3.3Vdc Output and 25A Output Current



Applications

- Wireless Networks
- Optical and Access Network Equipment
- Enterprise Networks
- Latest generation IC's (DSP, FPGA, ASIC) and Microprocessor powered applications

Options

- Negative Remote On/Off Logic
- Auto-restart from Output overcurrent/voltage and Over-temperature Protections
- Heat plate version (-H)

Description

The QPW025A0F41 is a new open-frame DC/DC power module designed to provide up to 25A output current in an industry standard quarter brick package. The converter uses synchronous rectification technology and open-frame packaging techniques to achieve high efficiency reaching 92.5% at 3.3V full load.

Features

- Delivers up to 25A Output current
- High efficiency – 92.5% at 3.3V full load
- Industry standard Quarter brick footprint
57.9mm x 36.8mm x 12.7mm (with base plate)
(2.28in x 1.45in x 0.5in)
- Low output ripple and noise
- 2:1 Input voltage
- Input under voltage protection
- Output overcurrent/voltage protection
- Over-temperature protection
- Tightly regulated output
- Remote sense
- Adjustable output voltage (+10%/ -20%)
- Negative logic, Remote On/Off
- Auto restart after fault protection shutdown
- Wide operating temperature range (-40°C to 85°C)
- Meets the voltage insulation requirements for ETSI 300-132-2 and complies with and is Licensed for Basic Insulation rating per EN 60950
- CE mark meets the 2006/95/EC directive[§]
- *UL** 60950-1 Recognized, *CSA*[†] C22.2 No. 60950-1-03 Certified, and *VDE*[‡] 0805 (EN60950 3rd Edition) Licensed
- ISO** 9001 and ISO 14001 certified manufacturing facilities

* *UL* is a registered trademark of Underwriters Laboratories, Inc.

† *CSA* is a registered trademark of Canadian Standards Association.

‡ *VDE* is a trademark of Verband Deutscher Elektrotechniker e.V.

§ This product is intended for integration into end-user equipment. All of the required procedures of end-use equipment should be followed.

** *ISO* is a registered trademark of the International Organization of Standards

Absolute Maximum Ratings

Stresses in excess of the absolute maximum ratings can cause permanent damage to the device. These are absolute stress ratings only, functional operation of the device is not implied at these or any other conditions in excess of those given in the operations sections of the data sheet. Exposure to absolute maximum ratings for extended periods can adversely affect the device reliability.

Parameter	Device	Symbol	Min	Max	Unit
Input Voltage					
Continuous	All	V_{IN}	-	80	Vdc
Transient (100 ms)		$V_{IN,trans}$	-	100	Vdc
Operating Ambient Temperature (see Thermal Considerations section)	All	T_A	-40	85	°C
Storage Temperature	All	T_{stg}	-55	125	°C
I/O Isolation	All			1500	Vdc

Electrical Specifications

Unless otherwise indicated, specifications apply over all operating input voltage, resistive load, and temperature conditions.

Parameter	Device	Symbol	Min	Typ	Max	Unit
Operating Input Voltage	All	V_{IN}	36	48	75	Vdc
Maximum Input Current ($V_{IN}=0$ to $V_{IN,max}$, $V_o = V_{o,set}$, $I_o=I_{o,max}$)	All	$I_{IN,max}$	-		2.9	Adc
Quiescent Input Current Remote on / off disabled ($V_{IN} = V_{IN,nom}$)	All	$I_{IN,Q}$	-		5	mA
Idle Input Current Remote on / off enabled ($V_{IN} = V_{IN,nom}$, $I_o = 0$ A)	All	$I_{IN,Idle}$	-	60	-	mA
Inrush Transient	All	I^2t	-		1	A ² s
Input Reflected Ripple Current, peak-to-peak (5Hz to 20MHz, 12µH source impedance; T_a 25°C, C_{in} = TBD)	All		-	16	-	mAp-p
Input Ripple Rejection (100 - 120Hz)	All		-	60	-	dB

CAUTION: This power module is not internally fused. An input line fuse must always be used.

This power module can be used in a wide variety of applications, ranging from simple standalone operation to being part of complex power architecture. To preserve maximum flexibility, internal fusing is not included; however, to achieve maximum safety and system protection, always use an input line fuse. The safety agencies require a fast-acting fuse with a maximum rating of 6A (see Safety Considerations section). Based on the information provided in this data sheet on inrush energy and maximum dc input current, the same type of fuse with a lower rating can be used. Refer to the fuse manufacturer's data sheet for further information.

Electrical Specifications (continued)

Parameter	Symbol	Min	Typ	Max	Unit
Output Voltage Set-point ($V_{IN}=V_{IN,nom}$, $I_O=I_{O,max}$, $T_{ref}=25^{\circ}C$)	$V_{O,set}$	3.24 -1.6	3.3	3.36 +1.6	% $V_{O,set}$ % $V_{O,set}$
Output Voltage (Over all operating input voltage, resistive load, and temperature conditions until end of life)	V_O	3.2	-	3.4	% V_O
Output Regulation Line ($V_{IN} = V_{IN,min}$ to $V_{IN,max}$) Load ($I_O = I_{O,min}$ to $I_{O,max}$) Temperature ($T_{ref} = T_{A,min}$ to $T_{A,max}$)		— — —	0.05 0.05 0.15	0.2 0.2 0.50	% $V_{O,nom}$ % $V_{O,nom}$ % $V_{O,nom}$
Output Ripple and Noise on nominal output ($V_{IN}=V_{IN,nom}$ and $I_O = I_{O,min}$ to $I_{O,max}$, $C_{out} = 1\mu F$ ceramic // $10\mu F$ Tantalum capacitor)					
RMS (5Hz to 20MHz bandwidth)		—	10	20	mV _{rms}
Peak-to-Peak (5Hz to 20MHz bandwidth)		—	45	60	mV _{pk-pk}
External Capacitance	C_O	0	—	10000	μF
Output Current	I_O	0		25	A dc
Output Current Limit Inception (Hiccup Mode) ($V_O = 90\% V_{O,set}$)	$I_{O,lim}$	105	120	130	% $I_{O,max}$
Output Short-Circuit Current $V_O \leq 250$ mV @ $25^{\circ}C$	$I_{O,s/c}$	—	130	150	% $I_{O,max}$
Efficiency $V_{IN}=48V$, $T_A=25^{\circ}C$, $I_O=I_{O,max}$ A	η	—	92.5	—	%
Switching Frequency	f_{sw}	—	300	—	KHz
Dynamic Load Response ($di_O/dt=0.1A/\mu s$; $V_{IN}=V_{IN,nom}$; $T_A=25^{\circ}C$) Load change from $I_O = 50\%$ to 75% of $I_{O,max}$					
Peak Deviation	V_{pk}	—	5	—	% V_O
Settling Time ($V_O < 10\%$ peak deviation)	t_s	—	150	—	μs
Load change from $I_O = 50\%$ to 25% of $I_{O,max}$					
Peak Deviation	V_{pk}	—	5	—	% V_O
Settling Time ($V_O < 10\%$ peak deviation)	t_s	—	150	—	μs

Isolation Specifications

Parameter	Symbol	Min	Typ	Max	Unit
Isolation Capacitance	C_{ISO}	—	2700	—	pF
Isolation Resistance	R_{ISO}	10	—	—	M Ω

General Specifications

Parameter	Symbol	Min	Typ	Max	Unit
Calculated Reliability based upon Telcordia SR-332, Issue 2; Method I Case 3 ($I_O=80\%$ of $I_{O,max}$, $T_A=40^{\circ}C$, airflow = 200 lfm, 90% confidence)	MTBF FIT		2,808,445 356		Hours 10 ⁹ /Hours
Weight		—	31 (1.1)	—	g (oz.)

Feature Specifications

Unless otherwise indicated, specifications apply over all operating input voltage, resistive load, and temperature conditions. See Feature Descriptions for additional information.

Parameter	Symbol	Min	Typ	Max	Unit
On/Off Signal interface ($V_I = V_{I,min}$ to $V_{I,max}$; Open collector or equivalent) Compatible, signal referenced to V_I (-) terminal Logic High (Module ON) Input High Voltage Input High Current Logic Low (Module OFF) Input Low Voltage Input Low Current	V_{IH} I_{IH} V_{IL} I_{IL}	7 — 0 —	— — — —	15 50 1.2 1	V μ A V mA
Turn-On Delay and Rise Times ($I_O=80\% I_{O,max}$, $V_{IN}=V_{IN,nom}$, $T_A = 25^\circ\text{C}$) Case 1: On/Off input is set to Logic High (Module ON) and then input power is applied (delay from instant at which $V_{IN} = V_{IN,min}$ until $V_O=10\%$ of $V_{O,set}$) Case 2: Input power is applied for at least one second and then the On/Off input is set to logic high (delay from instant at which $V_{on/Off}=0.9V$ until $V_O=10\%$ of $V_{O,set}$) Output voltage Rise time (time for V_O to rise from 10% of $V_{O,set}$ to 90% of $V_{O,set}$)	T_{delay} T_{delay} T_{rise}	— — —	5 2.5 4	— — —	msec msec msec
Output Voltage Remote Sense		—	—	10	% $V_{O,set}$
Output voltage overshoot – Startup $I_O = 80\%$ of $I_{O,max}$; $T_A = 25^\circ\text{C}$			—	1	% $V_{O,set}$
Over temperature Protection (See Thermal Considerations section)	T_{ref}	—	115	—	$^\circ\text{C}$
Input Undervoltage Lockout Turn-on Threshold Turn-off Threshold Hysteresis	V_{UVLO}	— 30	34.5 31.5 3	36 —	V V
Output voltage adjustment range(TRIM)		80	—	110	% $V_{O,set}$
Over voltage protection		3.8	—	4.6	Vdc

Characteristic Curves

The following figures provide typical characteristics for QPW025A0F41/QPW025A0F41-H at 25°C

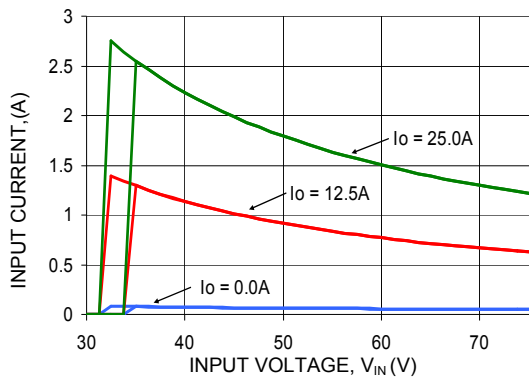

Figure 1. Typical Start-Up (Input Current) characteristics at room temperature.

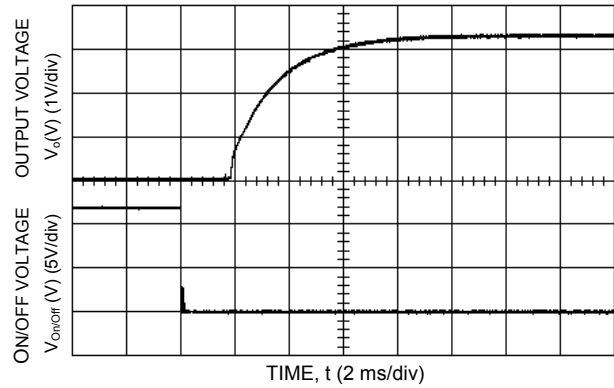

Figure 4. Typical Start-Up Characteristics from Remote ON/OFF.

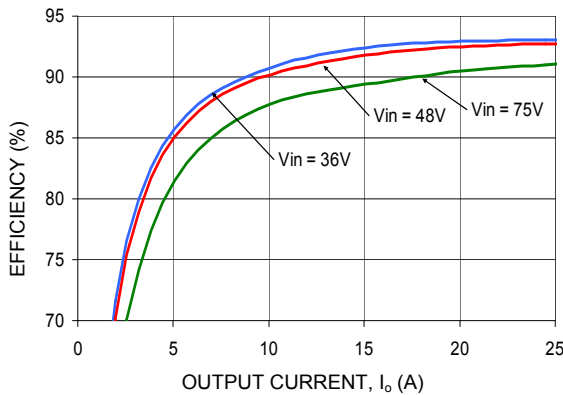

Figure 2. Converter Efficiency Vs Load at $V_o = 3.3$ V.

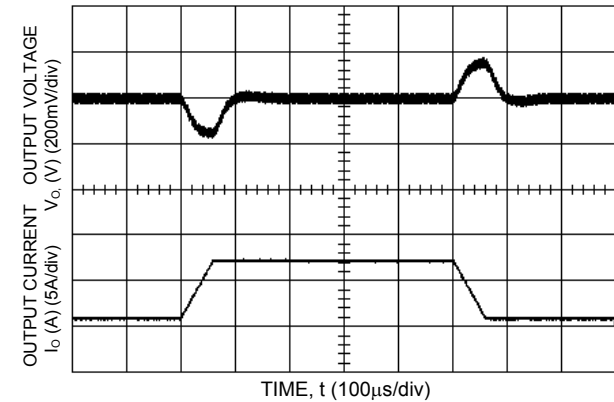

Figure 5. Transient Response to Dynamic Load Change from 50% to 25% to 50% of full load current.

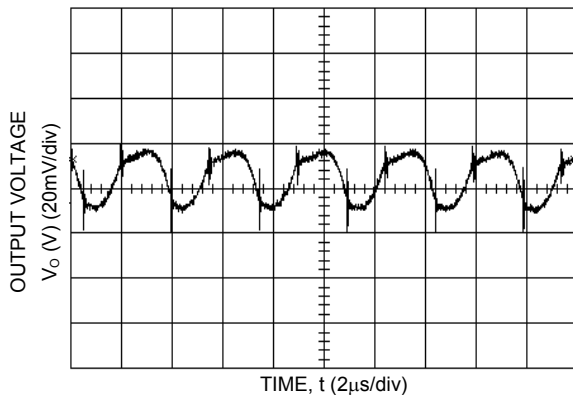

Figure 3. Typical Output Ripple and Noise at $V_{in} = 48$ Vdc.

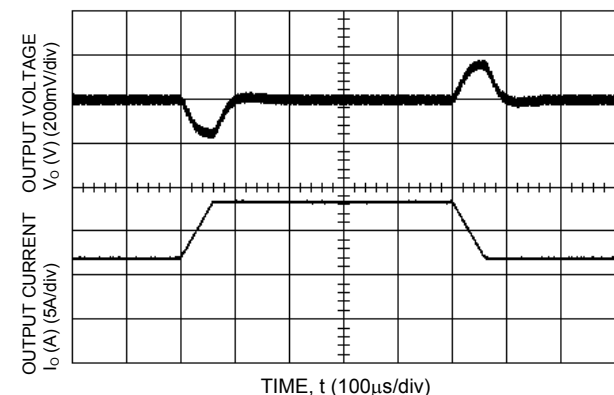
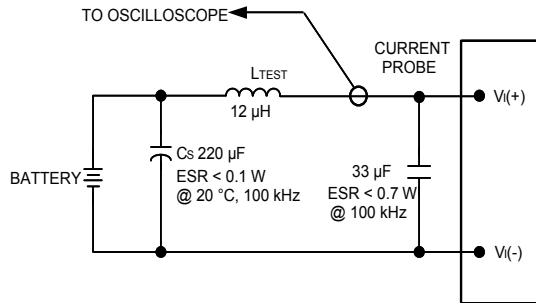

Figure 6. Transient Response to Dynamic Load Change from 75% to 50% to 75% of full load current.

Test Configurations



Note: Input reflected-ripple current is measured with the simulated source inductance of 1µH. Capacitor Cs offsets possible battery impedance. Current is measured at the input of the module

Figure 7. Input Reflected Ripple Current Test Setup.

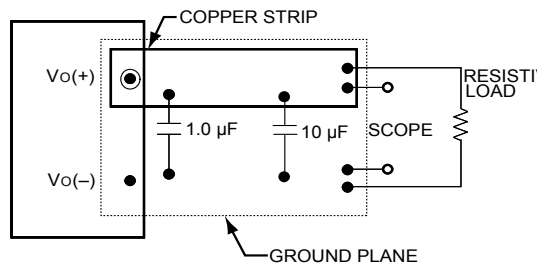

Note: Use a 10µF tantalum and a 1µF ceramic capacitor. Scope measurement should be made using BNC socket. Position the load between 51 mm and 76mm (2 in. and 3 in.) from the module

Figure 8. Output Ripple and Noise Test Setup.

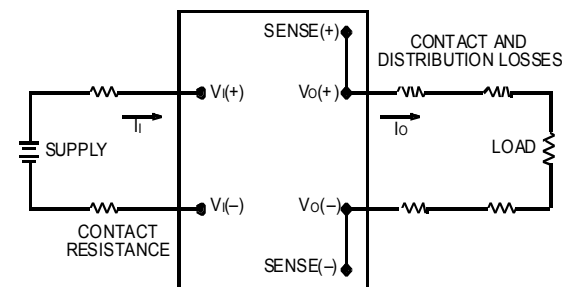

Figure 9. Output Voltage and Efficiency Test Setup.

$$\text{Efficiency } \eta = \frac{V_o \cdot I_o}{V_{IN} \cdot I_{IN}} \times 100 \%$$

Design Considerations

Input Source Impedance

The power module should be connected to a low ac-impedance input source. Highly inductive source impedances can affect the stability of the power module. For the test configuration in Figure 7, a 33 µF electrolytic capacitor (ESR < 0.7 Ω at 100 kHz) mounted close to the power module helps ensure stability of the unit. Consult the factory for further application guidelines.

Output Capacitance

High output current transient rate of change (high di/dt) loads may require high values of output capacitance to supply the instantaneous energy requirement to the load. To minimize the output voltage transient drop during this transient, low E.S.R. (equivalent series resistance) capacitors may be required, since a high E.S.R. will produce a correspondingly higher voltage drop during the current transient.

Output capacitance and load impedance interact with the power module's output voltage regulation control system and may produce an 'unstable' output condition for the required values of capacitance and E.S.R. Minimum and maximum values of output capacitance and of the capacitor's associated E.S.R. may be dictated, depending on the module's control system.

The process of determining the acceptable values of capacitance and E.S.R. is complex and is load-dependant. Lineage Power provides Web-based tools to assist the power module end-user in appraising and adjusting the effect of various load conditions and output capacitances on specific power modules for various load conditions

Safety Considerations

For safety-agency approval of the system in which the power module is used, the power module must be installed in compliance with the spacing and separation requirements of the end-use safety agency standard, i.e., UL60950-1, CSA C22.2 No. 60950-1-03, EN60950-1 and VDE 0805:2001-12.

For end products connected to -48V dc, or -60Vdc nominal DC MAINS (i.e. central office dc battery plant), no further fault testing is required. For all input voltages, other than DC MAINS, where the input voltage is less than 60V dc, if the input meets all of the requirements for SELV, then:

- The output may be considered SELV. Output voltages will remain within SELV limits even with internally-generated non-SELV voltages. Single

component failure and fault tests were performed in the power converters.

- One pole of the input and one pole of the output are to be grounded, or both circuits are to be kept floating, to maintain the output voltage to ground voltage within ELV or SELV limits.

For all input sources, other than DC MAINS, where the input voltage is between 60 and 75V dc (Classified as TNV-2 in Europe), the following must be met, if the converter's output is to be evaluated for SELV:

- The input source is to be provided with reinforced insulation from any hazardous voltage, including the ac mains.
- One V_i pin and one V_o pin are to be reliably earthed, or both the input and output pins are to be kept floating.
- Another SELV reliability test is conducted on the whole system, as required by the safety agencies, on the combination of supply source and the subject module to verify that under a single fault, hazardous voltages do not appear at the module's output.

The power module has ELV (extra-low voltage) outputs when all inputs are ELV.

All flammable materials used in the manufacturing of these modules are rated 94V-0, or tested to the UL60950 A.2 for reduced thickness.

The input to these units is to be provided with a maximum 6A fast-acting (or time-delay) fuse in the unearthed lead.

Feature Descriptions

Remote On/Off

Two remote On/Off logic options are available. Positive logic remote On/Off turns the module ON during a logic-high voltage on the remote On/Off pin, and turns the module OFF during a logic-low. Negative logic remote On/Off turns the module OFF during a logic-high and turns the module ON during logic-low. Negative logic is specified by suffix "1" at the end of the device code.

To turn the power module on and off, the user must supply a switch to control the voltage between the ON/OFF pin and the $V_{IN(-)}$ terminal ($V_{on/off}$). The switch may be an open collector or equivalent (see Figure 10). A logic-low is $V_{on/off} = 0$ V to 1.2V. The maximum $I_{on/off}$ during a logic low is 1 mA. The switch should maintain a logic-low voltage while sinking 1 mA.

During a logic-high, the maximum $V_{on/off}$ generated by the power module is 15 V. The maximum allowable leakage current of the switch is 50 μ A. If not using the remote on/off feature, do one of the following:

For positive logic, leave the ON/OFF pin open.

For negative logic, short the ON/OFF pin to $V_{IN(-)}$.

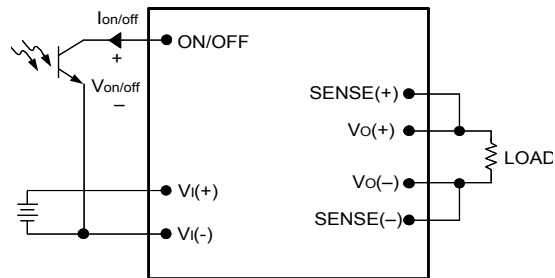

Figure 10. Circuit configuration for using Remote On/Off Implementation.

Overcurrent Protection

To provide protection in a fault (output overload) condition, the module is equipped with internal current-limiting circuitry, and can endure current limiting continuously. At the instance of current-limit inception, the output current begins to tail-out. When an overcurrent condition exists beyond a few seconds, the module enters a "hiccup" mode of operation, whereby it shuts down and automatically attempts to restart. While the fault condition exists, the module will remain in this hiccup mode, and can remain in this mode until the fault is cleared. The unit

Feature Descriptions (continued)

operates normally once the output current is reduced back into its specified range.

Input Undervoltage Lockout

At input voltages below the input undervoltage lockout limit, the module operation is disabled. The module will begin to operate at an input voltage between the undervoltage lockout limit and the minimum operating input voltage.

Overtemperature Protection

To provide over temperature protection in a fault condition, the unit relies upon the thermal protection feature of the controller IC. The unit will shut down if the thermal reference point T_{ref} exceeds the specified maximum temperature threshold, but the thermal shutdown is not intended as a guarantee that the unit will survive temperatures beyond its rating. The module will automatically restart after it cools down.

Over Voltage Protection

The output overvoltage protection clamp consists of control circuitry, independent of the primary regulation loop, which monitors the voltage on the output terminals. This control loop has a higher voltage set point than the primary loop (See the overvoltage clamp values in the Feature Specifications). In a fault condition, the overvoltage clamp ensures that the output voltage does not exceed $V_{o, clamp(max)}$. This provides a redundant voltage-control that reduces the risk of output overvoltage.

Remote sense

Remote sense minimizes the effects of distribution losses by regulating the voltage at the remote-sense connections (See Figure 11). The voltage between the remote-sense pins and the output terminals must not exceed the output voltage sense range given in the Feature Specifications table:

$$[V_{O(+)} - V_{O(-)}] - [SENSE(+)-SENSE(-)] \leq 10\% \text{ of } V_{O, rated}$$

The voltage between the $V_{O(+)}$ and $V_{O(-)}$ terminals must not exceed the minimum output overvoltage shutdown value indicated in the Feature Specifications table. This limit includes any increase in voltage due to remote-sense compensation and output voltage setpoint adjustment (trim) (see Figure 11). If not using the remote-sense feature to regulate the output at the point of load, then connect SENSE(+) to $V_{O(+)}$ and SENSE(-) to $V_{O(-)}$ at the module.

The amount of power delivered by the module is defined as the voltage at the output terminals multiplied by the output current. When using remote sense and trim, the output voltage of the module can

be increased, which, at the same output current, would increase the power output of the module. Care should be taken to ensure that the maximum output power of the module remains at or below the maximum rated power (Maximum rated power = $V_{O, set} \times I_{O, max}$).

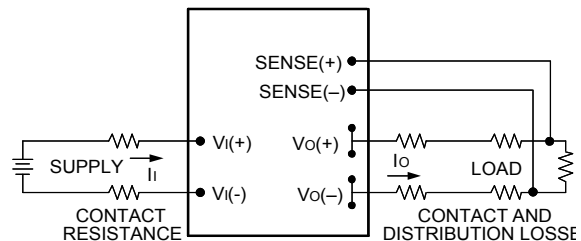

Figure 11. Circuit Configuration to program output voltage using external resistor.

Output Voltage Programming

Trimming allows the user to increase or decrease the output voltage set point of a module. This is accomplished by connecting an external resistor between the TRIM pin and either the SENSE(+) or SENSE(-) pins. A resistor placed between the Trim pin and Sense (+) increases the output voltage and a resistor placed between the Trim pin and Sense (-) decreases the output voltage. Figure 12 shows the circuit configuration using an external resistor. The trim resistor should be positioned close to the module. If the trim pin is not used then the pin shall be left open.

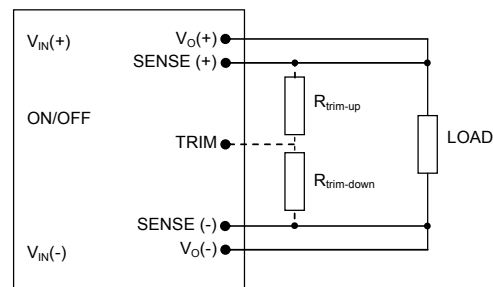

Figure 12. Circuit Configuration to program output voltage using an external resistor.

The following equations determine the required external resistor value to obtain a percentage output voltage change of $\Delta\%$.

To decrease output voltage set point:

$$R_{trim-down} = \left(\frac{510}{\Delta\%} - 10.2 \right) K\Omega$$

Where,

$$\Delta\% = \left| \frac{V_{o, nom} - V_{desired}}{V_{o, nom}} \right| \times 100$$

$V_{desired}$ = Desired output voltage set point (V).

To increase the output voltage set point

$$R_{trim-up} = \left(\frac{5.1 * V_{o, nom} * (100 + \Delta\%)}{1.225 * \Delta\%} - \frac{510}{\Delta\%} - 10.2 \right) K\Omega$$

Although the output voltage can be increased by both the remote sense and by the trim, the maximum increase for the output voltage is not the sum of both. The maximum increase is the larger of either the remote sense or the trim.

Thermal Considerations

The power modules operate in a variety of thermal environments; however, sufficient cooling should be provided to help ensure reliable operation of the unit. Heat-dissipation components are mounted on the topside of the module. Heat is removed by conduction, convection and radiation to the surrounding environment. Proper cooling can be verified by measuring the temperature of selected components on the topside of the power module. Peak temperature can occur at any to these positions indicated in the following figure 14.

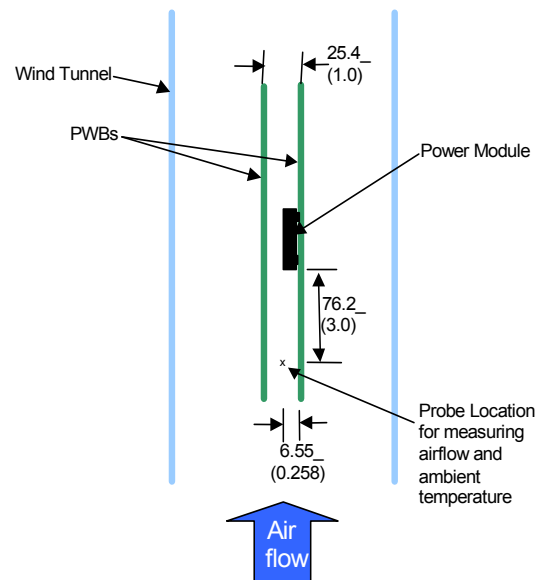
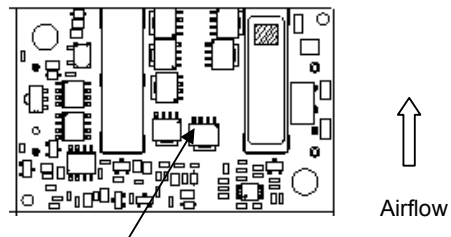

Figure 13. Thermal Test Set up.

The temperature at any one of these locations should not exceed 115 °C to ensure reliable operation of the power module. The output power of the module should not exceed the rated power for the module as listed in the Ordering Information table.



Thermocouple Location $T_{ref}=115^{\circ}C$

Figure 14. T_{ref} Temperature measurement location.

Please refer to the Application Note “Thermal Characterization Process For Open-Frame Board-Mounted Power Modules” for a detailed discussion of thermal aspects including maximum device temperatures.

Heat Transfer via Convection

Increased airflow over the module enhances the heat transfer via convection. Thermal derating curves showing the maximum output current that can be delivered by the module versus local ambient temperature (T_A) for natural convection, 0.5m/s (100 ft./min) and 1.0 m/s (200 ft./min) are shown in Fig. 15 for the bare module and in Fig. 16 for the module with baseplate.

Note that the natural convection condition was measured at 0.05m/s to 0.1m/s (10ft./min. to 20ft./min.); however, systems in which these power modules may be used typically generate natural convection airflow rates of 0.3m/s (60 ft./min.) due to other heat dissipating components in the system.

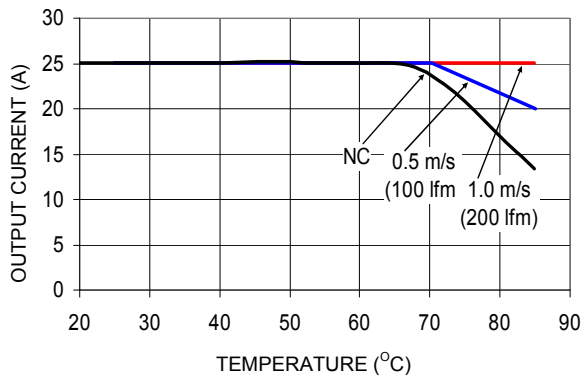

Figure 15. Thermal Derating Curves for the QPW025A0F41 module at 48Vin. Airflow is in the transverse direction (Vin- to Vin+).

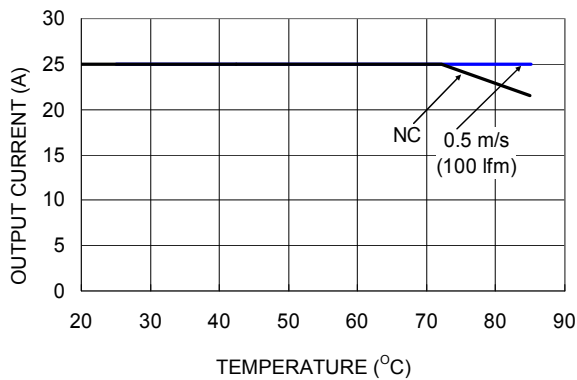

Figure 16. Thermal Derating Curves for the QPW025A0F41-H baseplate module at 48Vin. Airflow is in the transverse direction (Vin- to Vin+).

Mechanical Outline

Dimensions are in millimeters and [inches].

Tolerances: x.x mm ± 0.5 mm [x.xx in. ± 0.02 in.] (unless otherwise indicated)

x.xx mm ± 0.25 mm [x.xxx in ± 0.010 in.]

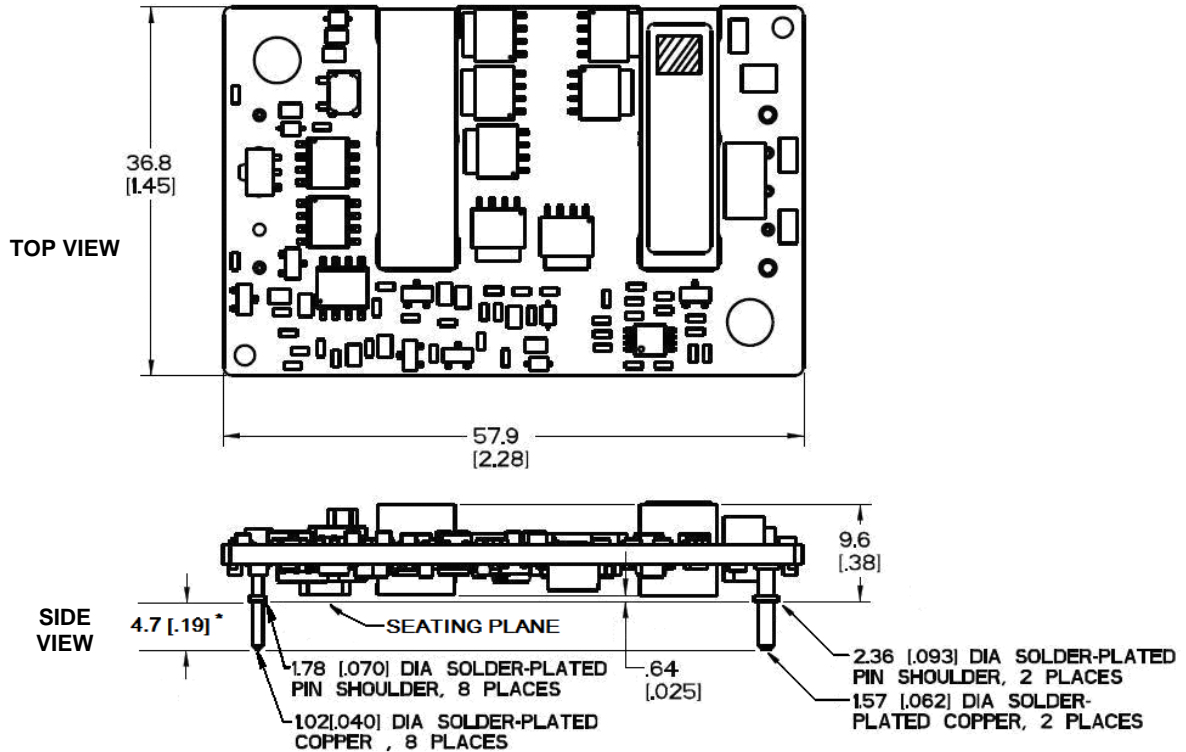

* FOR OPTIONAL PIN LEAD LENGTHS, SEE TABLE 2, DEVICE OPTIONS.

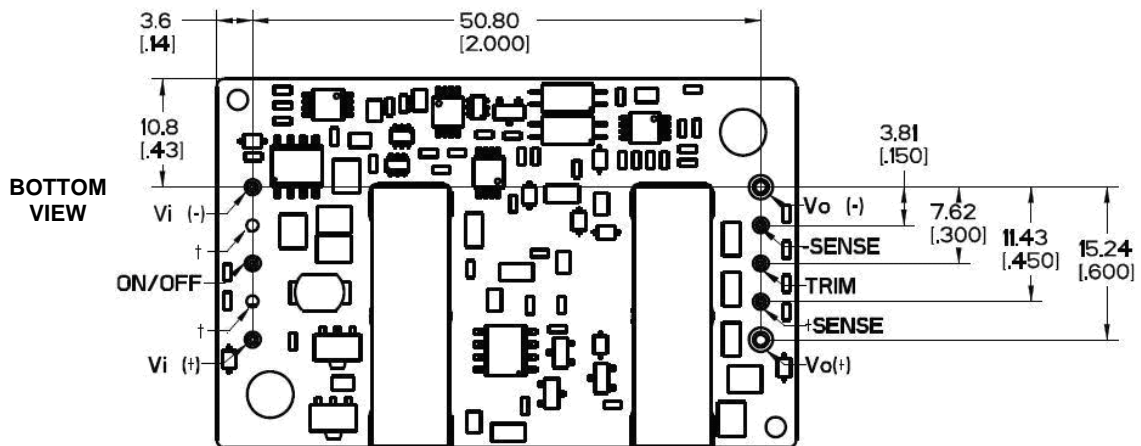

† -Optional pin

Mechanical Outline for module with base plate.

Dimensions are in millimeters and [inches].

Tolerances: x.x mm ± 0.5 mm [x.xx in. ± 0.02 in.] (unless otherwise indicated)

x.xx mm ± 0.25 mm [x.xxx in ± 0.010 in.]

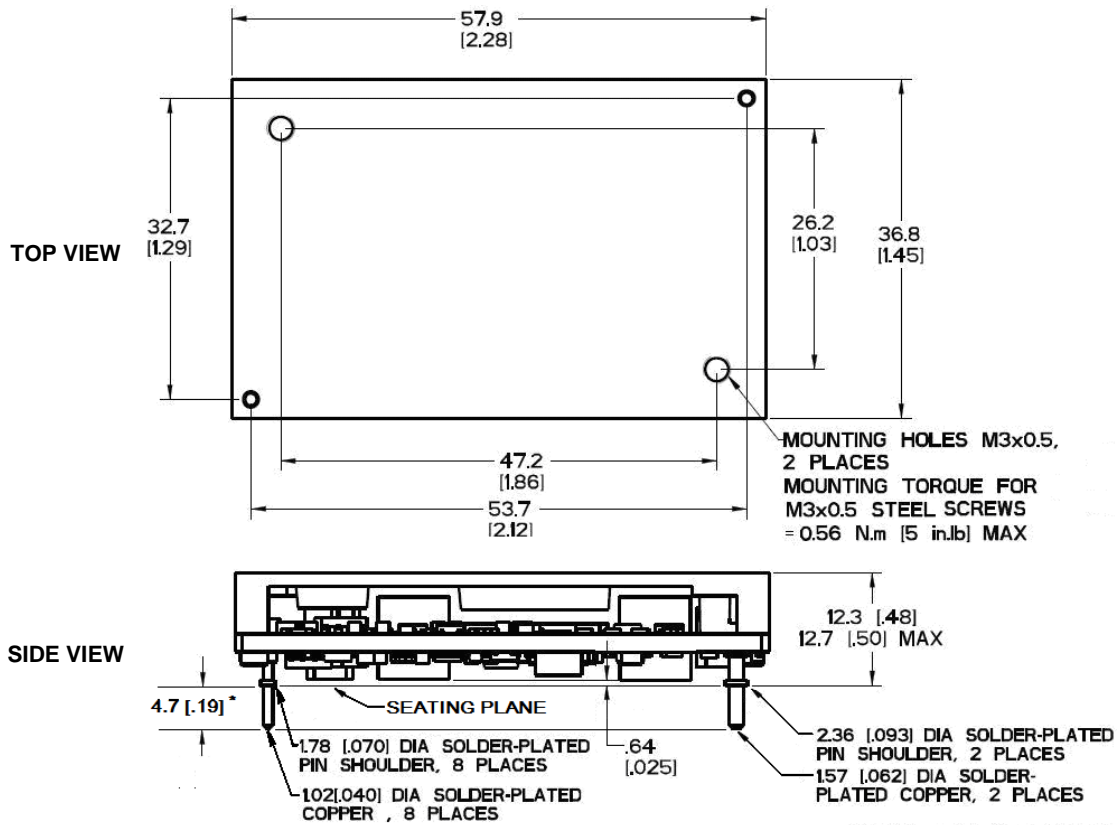

* FOR OPTIONAL PIN LEAD LENGTHS, SEE TABLE 2, DEVICE OPTIONS.

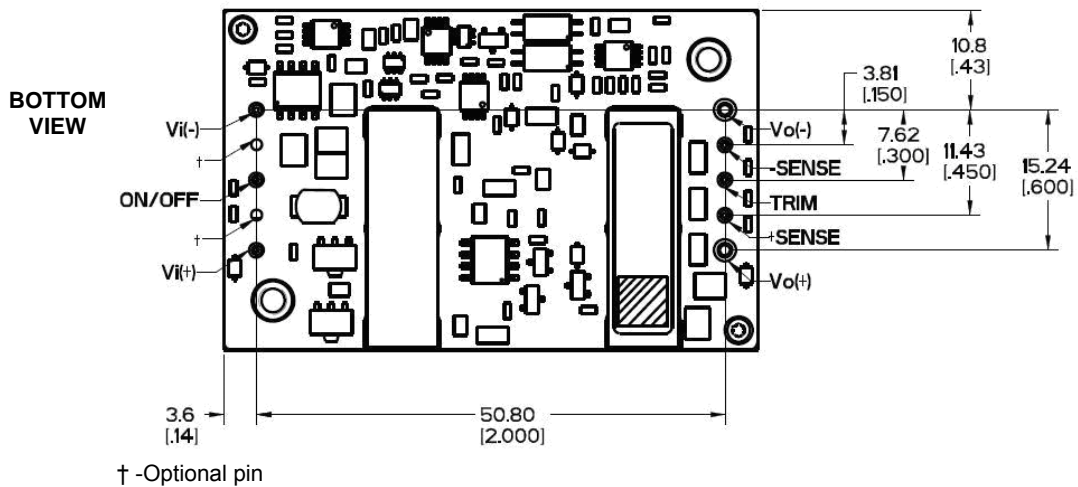

Recommended Pad Layout

Dimensions are in millimeters and (inches).

Tolerances: x.x mm ± 0.5 mm (x.xx in. ± 0.02 in.) (unless otherwise indicated)

x.xx mm ± 0.25 mm (x.xxx in ± 0.010 in.)

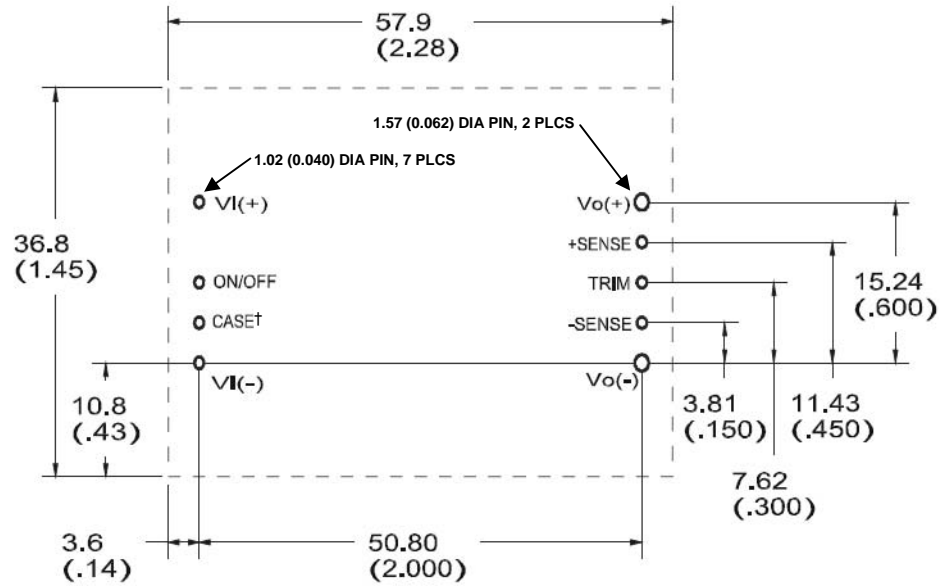

† - Option

Ordering Information

Please contact your Lineage Power Sales Representative for pricing, availability and optional features.

Table 3. Device Code

Input Voltage	Output Voltage	Output Current	Efficiency	Connector Type	Product codes	Comcodes
36 – 75Vdc	3.3 V	25A	92.5%	Through-Hole	QPW025A0F41-H	108993572

Table 2. Device Options

Option	Device Code Suffix
Negative Logic Remote On/Off	1
Auto-restart after fault shutdown	4
Pin Length: 3.68 mm ± 0.25 mm (0.145 in. ± 0.010 in.)	6
Case pin (only available with –H option)	7
Base plate version for heat sink attachment	-H



World Wide Headquarters
Lineage Power Corporation
601 Shiloh Road, Plano, TX 75074, USA
+1-800-526-7819
(Outside U.S.A.: **+1-972-244-9428**)
www.lineagepower.com
e-mail: techsupport1@lineagepower.com

Asia-Pacific Headquarters
Tel: +65 6593 7211

Europe, Middle-East and Africa Headquarters
Tel: +49 898 780 672 80

India Headquarters
Tel: +91 80 28411633

Lineage Power reserves the right to make changes to the product(s) or information contained herein without notice. No liability is assumed as a result of their use or application. No rights under any patent accompany the sale of any such product(s) or information.

Lineage Power DC-DC products are protected under various patents. Information on these patents is available at www.lineagepower.com/patents.

© 2009 Lineage Power Corporation, (Plano, Texas) All International Rights Reserved.