

KEY FEATURES

- Universal Input: 90-264 VAC
- With P.F.C. Function, PF>0.95
- Remote ON/OFF Function
- Current Share Function
- Power Good Function
- High Efficiency up to 90~93%
- Protections: Over Load / Over Voltage /
Over Temperature / Short Circuit
- High Power Density
- RoHS Compliant Design
- 3-Years Product Warranty



ELECTRICAL SPECIFICATIONS

Model No.	AQF600-12S	AQF600-24S	AQF600-48S	AQF600-54S
Max Output Wattage (Convection) (W)	540W	600W	600W	600W
Input	Voltage			
	90-264 VAC or 120-370 VDC			
	Frequency (Hz)			
	47-63 Hz			
	Current (Full load)			
	< 8.0 A max. (115 VAC) / < 3.5 A max. (230 VAC)			
Inrush Current (<2ms)				
< 15 A max. (115 VAC) / < 30 A max. (230 VAC)				
Leakage Current				
< 3.5 mA max.(240VAC 63Hz)				
Power Factor				
PF>0.99 (115 VAC) / PF>0.95 (230 VAC) at Full Load				
Output	Voltage (V.DC.)			
	12V	24V	48V	54V
	Trim			
	±5%			
	Voltage Accuracy			
	±2%			
	Current (Convection) (A) max			
	45	25	12.5	11.1
	Line Regulation (LL-HL) (typ.)			
	±1%			
	Load Regulation (5-100%) (typ.)			
	±1%			
	Minimum Load			
1%				
Maximum Capacitive Load				
90,000 uF	70,000 uF	30,000 uF	20,000 uF	
Ripple & Noise (max.)				
< 1%				
Efficiency (typ.)				
90%	92%	92%	93%	
Hold-up Time				
15 ms min.				
Switching Frequency				
100±10 KHz				
Protection	Over Power Protection			
	Auto recovery			
	Over Voltage Protection			
	Auto recovery			
Over Temperature				
Auto recovery				
Short Circuit Protection				
Latch off				
Isolation	Input-Output (V.AC)			
	3000V			
	Input-FG (V.AC)			
1500V				
Output-FG (V.AC)				
500V				
Function	5V Stand by (18CFM FAN)			
	5VSB: 5V@0.6A ; Tolerance ±10% , Ripple & Noise: 100m Vp-p (max.)			
	DC OK Signal (Power Good)			
	Turn ON: 4~6V ; Turn OFF: 0~1V			
Remote Control				
+RC / -RC: Power ON=open ; Power OFF=short				
Current Share				
CN4:CS, +V, -V are connected mutually in parallel.				
Environment	Operating Temperature			
	-25°C...+65°C (with derating)			
	Storage Temperature			
	-25°C...+85°C			
	Temperature Coefficient			
±0.03%/°C (0~50°C)				
Humidity				
95% RH				
MTBF				
>100,000 h @ 25°C (MIL-HDBK-217F)				
Vibration				
10~500Hz, 2G 10min./1cycle, 60min. each along X, Y, Z axes.				

1. All specifications valid at normal input voltage, full load and +25°C after warm-up time unless otherwise stated.
2. Ripple & Noise are measured at 20MHz of bandwidth with 0.1uF & 47uF parallel capacitor.

ELECTRICAL SPECIFICATIONS

Model No.	AQF600-12S	AQF600-24S	AQF600-48S	AQF600-54S
Physical	Dimension (L x W x H) 9.0 x 4.13 x 1.72 Inches (228.5 x 105.0 x 44.0 mm) Tolerance ± 0.5 mm			
	Weight 1024 \pm 50 g			
	Cooling Integral fan			
Safety	Agency Approvals CE, UL60950-1			
EMC	EMI (Conducted & Radiated Emission) EN 55022 class B, Radiated Class A			
	EMS (Noise Immunity) EN 55024			

1. All specifications valid at normal input voltage, full load and +25°C after warm-up time unless otherwise stated.
2. Ripple & Noise are measured at 20MHz of bandwidth with 0.1 μ F & 47 μ F parallel capacitor.

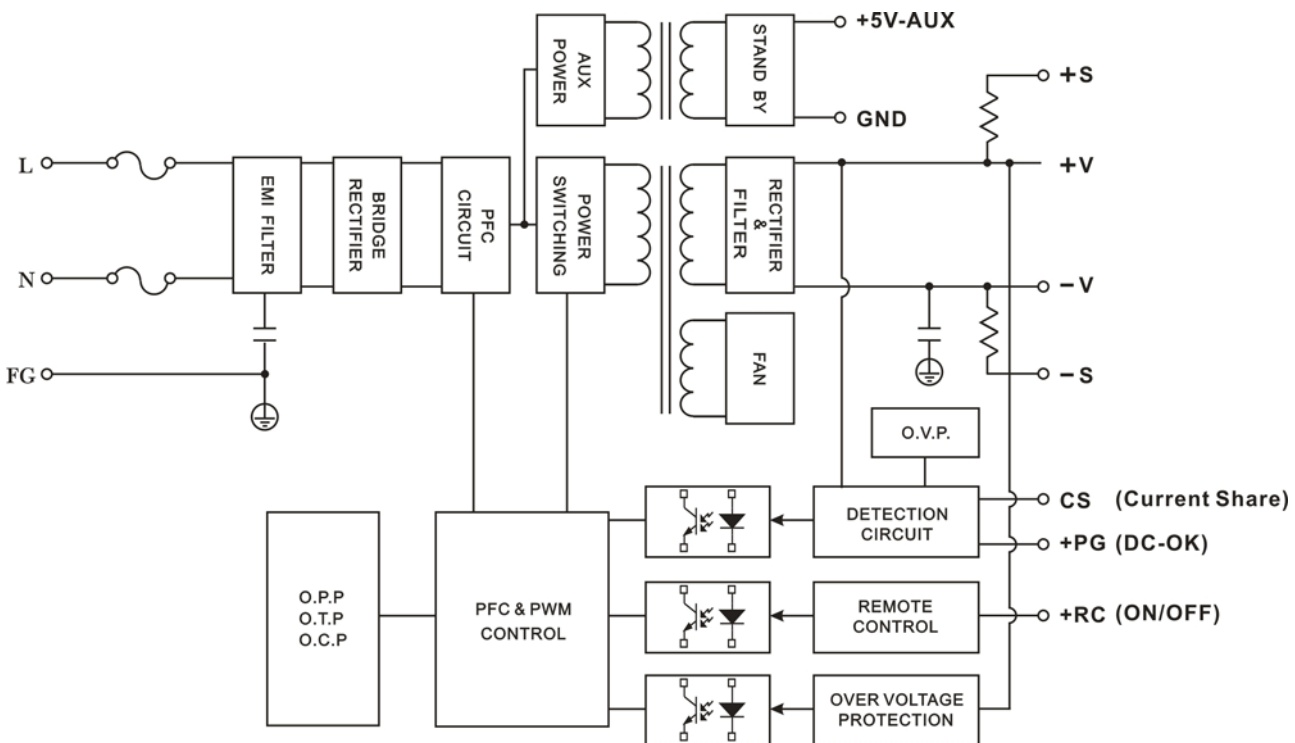
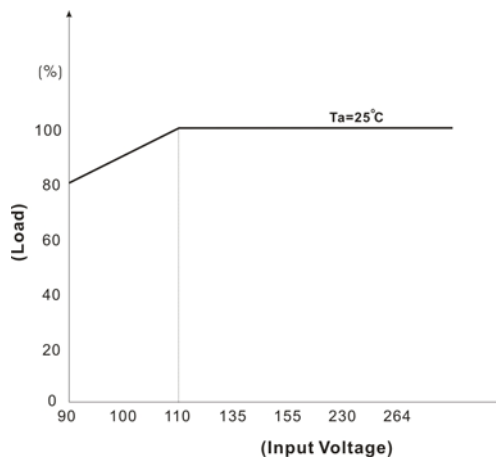
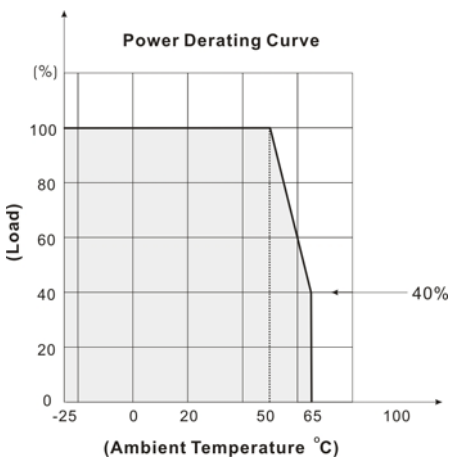
BLOCK DIAGRAM

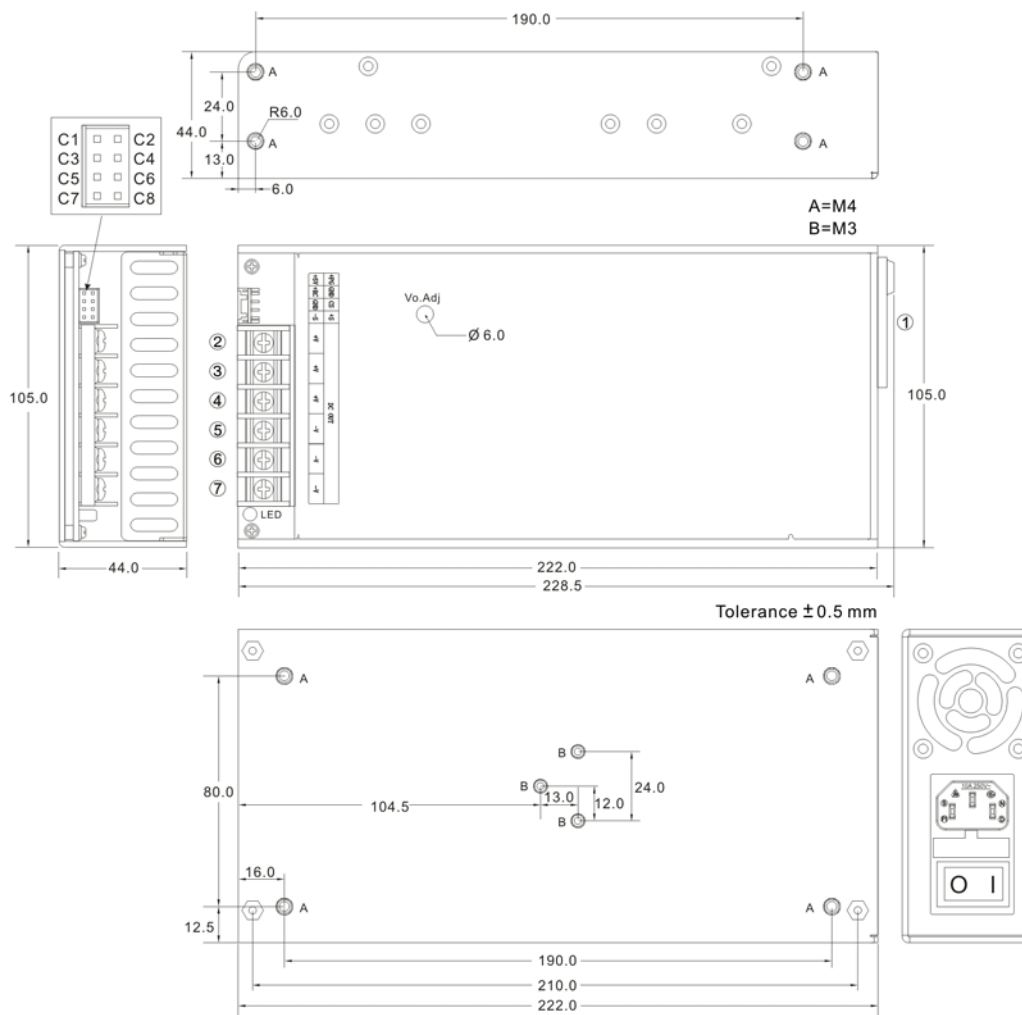
DERATING

MECHANICAL DIMENSION

AC Input Terminal Pin

PIN#	SINGLE
1	AC IN

DC Output Terminal Pin

PIN#	SINGLE
2~4	+DC OUT
5~7	-DC OUT

Connector Pin (CN4)

PIN#	SINGLE
C1	+S
C2	-S
C3	CS
C4	GND
C5	GND
C6	+RC
C7	+PG
C8	+5V-AUX

ASSEMBLY INSTRUCTIONS

*U Case T=2.0mm

Customer screws into the length of the case no higher than 0.5mm
(Namely screw length for load plate thickness plus 2.5mm)

FUNCTION DESCRIPTION of CN4

Pin No.	Function	Description
C1	+S	Current Share Function Pin
C2	-S	
C3	CS	
C4	GND	This pin connects to the negative terminal(-V). Return for DC-OK signal output.
C5	GND	This pin connects to the negative terminal(-V). Return for DC-OK signal output.
C6	+RC	Turns the output on and off by electrical or dry contact between pin C4 (-RC), Short: Power OFF, Open: Power ON.
C7	+PG	DC-OK Signal is a DC output, referenced to pinC6(DC-OK GND).
C8	+5V-AUX	Stand by voltage output ground 4.5~5.5V, referenced to pin C4 or C5(GND). The maximum load current is 0.6A.

FUNCTION MANUAL
1. DC-OK Signal

Between DC-OK(pinC5) and GND(pinC6)	Output Status
4~6V	ON
0~1V	OFF

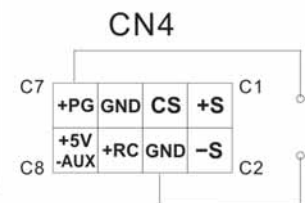
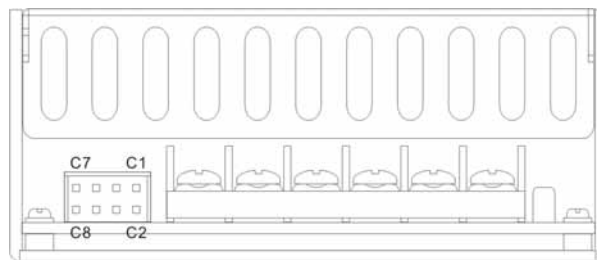
2. Remote Control

It can be turned ON/OFF by using the "Remote Control" function.

Between RC+(pinC3) and RC-(pinC4)	Output Status
SW ON (Short)	OFF
SW OFF (Open)	ON

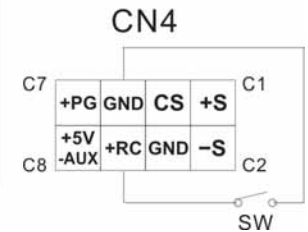
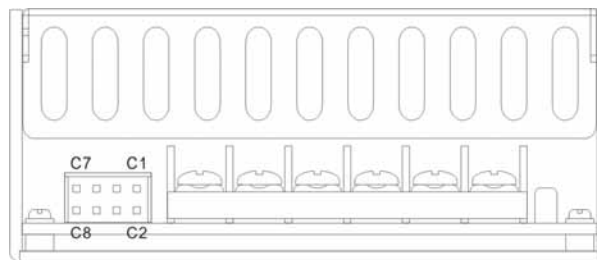
3. Current Share

1. Difference in Vout among paralleled units should be less than +/-1%
2. Output Power at Parallel Operation = Rated Power per Unit x Number of Unit x 80%
3. Connect in parallel no more than 3 units. Please contact Arch for advice if more than 3 is needed.
4. Shorter wiring to each unit is recommended, as well as twisting +S and -S in pairs, as shown below

